



**NONRESIDENT  
TRAINING  
COURSE**



April 1999

---

# **Aerographer's Mate**

## **Module 2—Miscellaneous Observations and Codes**

**NAVEDTRA 14270**

Although the words “he,” “him,” and “his” are used sparingly in this course to enhance communication, they are not intended to be gender driven or to affront or discriminate against anyone.

## PREFACE

By enrolling in this self-study course, you have demonstrated a desire to improve yourself and the Navy. Remember, however, this self-study course is only one part of the total Navy training program. Practical experience, schools, selected reading, and your desire to succeed are also necessary to successfully round out a fully meaningful training program.

**THE COURSE:** This self-study course is organized into subject matter areas, each containing learning objectives to help you determine what you should learn along with text and illustrations to help you understand the information. The subject matter reflects day-to-day requirements and experiences of personnel in the rating or skill area. It also reflects guidance provided by Enlisted Community Managers (ECMs) and other senior personnel, technical references, instructions, etc., and either the occupational or naval standards, which are listed in the *Manual of Navy Enlisted Manpower Personnel Classifications and Occupational Standards*, NAVPERS 18068.

**THE QUESTIONS:** The questions that appear in this course are designed to help you understand the material in the text.

**VALUE:** In completing this course, you will improve your military and professional knowledge. Importantly, it can also help you study for the Navy-wide advancement in rate examination. If you are studying and discover a reference in the text to another publication for further information, look it up.

*1999 Edition Prepared by  
AGC(SW) Stephen M. Volpe  
AGC(SW) Daniel T. Hoffman*

Published by  
NAVAL EDUCATION AND TRAINING  
PROFESSIONAL DEVELOPMENT  
AND TECHNOLOGY CENTER

**NAVSUP Logistics Tracking Number  
0504-LP-026-8990**

## **Sailor's Creed**

“I am a United States Sailor.

I will support and defend the Constitution of the United States of America and I will obey the orders of those appointed over me.

I represent the fighting spirit of the Navy and those who have gone before me to defend freedom and democracy around the world.

I proudly serve my country's Navy combat team with honor, courage and commitment.

I am committed to excellence and the fair treatment of all.”

# CONTENTS

<b>CHAPTER</b>	<b>PAGE</b>
1. Upper-Air Observations . . . . .	1-1
2. Bathythermograph Observations . . . . .	2-1
3. Aviation Weather Codes . . . . .	3-1
4. Surf Observations . . . . .	4-1
5. Plotting Radiological Fallout and Chemical Contamination Coverage . . . . .	5-1
<b>APPENDIX</b>	
I. Glossary. . . . .	AI-1
II. Marsden Square Chart . . . . .	AII-1
III. WMO Code Table 3333. . . . .	AIII-1
IV. WMO Code Tables 1770 and 4770 . . . . .	AIV-1
V. Degrees to Mils Conversion Chart. . . . .	AV-1
VI. References Used to Develop the TRAMAN . . . . .	AVI-1
<b>INDEX</b> . . . . .	<b>INDEX-1</b>

**Nonresident Training Course** Follows The Index

# SUMMARY OF THE AEROGRAPHER'S MATE TRAINING SERIES

The following modules of the AG training series are available:

## **AG MODULE 1, NAVEDTRA 14269, *Surface Weather Observations***

This module covers the basic procedures that are involved with conducting surface weather observations. It begins with a discussion of surface observation elements, followed by a description of primary and backup observation equipment that is used aboard ships and at shore stations. Module 1 also includes a complete explanation of how to record and encode surface METAR observations using WMO and NAVMETOCCOM guidelines. The module concludes with a description of WMO plotting models and procedures.

## **AG MODULE 2, NAVEDTRA 14270, *Miscellaneous Observations and Codes***

This module concentrates on the observation procedures, equipment, and codes associated with upper-air observations and bathythermograph observations. Module 2 also discusses aviation weather codes, such as TAFs and PIREPs, and includes a chapter on surf observation procedures. Radiological fallout and chemical contamination plotting procedures are also explained.

## **AG MODULE 3, NAVEDTRA 14271, *Environmental Satellites and Weather Radar***

This module describes the various type of environmental satellites, satellite imagery, and associated terminology. It also discusses satellite receiving equipment. In addition, Module 3 contains information on the Weather Surveillance Radar-1988 Doppler (WSR-88D). It includes a discussion of electromagnetic energy and radar propagation theory, and explains the basic principles of Doppler radar. The module also describes the configuration and operation of the WSR-88D, as well as WSR-88D products.

## **AG MODULE 4, NAVEDTRA 14272, *Environmental Communications and Administration***

This module covers several of the most widely used environmental communications systems within the METOC community. It also describes the software programs and products associated with these systems. The module concludes with a discussion of basic administration procedures.

### **NOTE**

Additional modules of the AG training series are in development. Check the NETPDTC website for details at <http://www.cnet.navy.mil/netpdtc/nac/neas.htm>. For ordering information, check NAVEDTRA 12061, Catalog of Nonresident Training Courses, which is also available on the NETPDTC website.

# SAFETY PRECAUTIONS

Safety is a paramount concern for all personnel. Many of the Naval Ship's Technical Manuals, manufacturer's technical manuals, and every Planned Maintenance System (PMS) maintenance requirement card (MRC) include safety precautions. Additionally, OPNAVINST 5100.19 (series), *Naval Occupational Safety and Health (NAVOSH) Program Manual for Forces Afloat*, and OPNAVINST 5100.23 (series), *NAVOSH Program Manual*, provide safety and occupational health information. The safety precautions are for your protection and to protect equipment.

During equipment operation and preventive or corrective maintenance, the procedures may call for personal protective equipment (PPE), such as goggles, gloves, safety shoes, hard hats, hearing protection, and respirators. When specified, your use of PPE is mandatory. You must select PPE appropriate for the job since the equipment is manufactured and approved for different levels of protection. If the procedure does not specify the PPE, and you aren't sure, ask your safety officer.

Most machinery, spaces, and tools requiring you to wear hearing protection are posted with hazardous noise signs or labels. Eye hazardous areas requiring you to wear goggles or safety glasses are also posted. In areas where corrosive chemicals are mixed or used, an emergency eyewash station must be installed.

All lubricating agents, oil, cleaning material, and chemicals used in maintenance and repair are hazardous materials. Examples of hazardous materials are gasoline, coal distillates, and asphalt. Gasoline contains a small amount of lead and other toxic compounds. Ingestion of gasoline can cause lead poisoning. Coal distillates, such as benzene or naphthalene in benzol, are suspected carcinogens. Avoid all skin contact and do not inhale the vapors and gases from these distillates. Asphalt contains components suspected of causing cancer. Anyone handling asphalt must be trained to handle it in a safe manner.

Hazardous materials require careful handling, storage, and disposal. PMS documentation provides hazard warnings or refers the maintenance man to the Hazardous Materials User's Guide. Material Safety Data Sheets (MSDS) also provide safety precautions for hazardous materials. All commands are required to have an MSDS for each hazardous material they have in their inventory. You must be familiar with the dangers associated with the hazardous materials you use in your work. Additional information is available from you command's *Hazardous Material Coordinator*. OPNAVINST 4110.2 (series), *Hazardous Material Control and Management*, contains detailed information on the hazardous material program.

Recent legislation and updated Navy directives implemented tighter constraints on environmental pollution and hazardous waste disposal. OPNAVINST 5090.1 (series), *Environmental and Natural Resources Program Manual*, provides detailed information. Your command must comply with federal, state, and local environmental regulations during any type of construction and demolition. Your supervisor will provide training on environmental compliance.

Cautions and warnings of potentially hazardous situations or conditions are highlighted, where needed, in each chapter of this TRAMAN. Remember to be safety conscious at all times.

# INSTRUCTIONS FOR TAKING THE COURSE

## ASSIGNMENTS

The text pages that you are to study are listed at the beginning of each assignment. Study these pages carefully before attempting to answer the questions. Pay close attention to tables and illustrations and read the learning objectives. The learning objectives state what you should be able to do after studying the material. Answering the questions correctly helps you accomplish the objectives.

## SELECTING YOUR ANSWERS

Read each question carefully, then select the BEST answer. You may refer freely to the text. The answers must be the result of your own work and decisions. You are prohibited from referring to or copying the answers of others and from giving answers to anyone else taking the course.

## SUBMITTING YOUR ASSIGNMENTS

To have your assignments graded, you must be enrolled in the course with the Nonresident Training Course Administration Branch at the Naval Education and Training Professional Development and Technology Center (NETPDTC). Following enrollment, there are two ways of having your assignments graded: (1) use the Internet to submit your assignments as you complete them, or (2) send all the assignments at one time by mail to NETPDTC.

**Grading on the Internet:** Advantages to Internet grading are:

- you may submit your answers as soon as you complete an assignment, and
- you get your results faster; usually by the next working day (approximately 24 hours).

In addition to receiving grade results for each assignment, you will receive course completion confirmation once you have completed all the

assignments. To submit your assignment answers via the Internet, go to:

**<http://courses.cnet.navy.mil>**

**Grading by Mail:** When you submit answer sheets by mail, send all of your assignments at one time. Do NOT submit individual answer sheets for grading. Mail all of your assignments in an envelope, which you either provide yourself or obtain from your nearest Educational Services Officer (ESO). Submit answer sheets to:

COMMANDING OFFICER  
NETPDTC N331  
6490 SAUFLEY FIELD ROAD  
PENSACOLA FL 32559-5000

**Answer Sheets:** All courses include one “scannable” answer sheet for each assignment. These answer sheets are preprinted with your SSN, name, assignment number, and course number. Explanations for completing the answer sheets are on the answer sheet.

**Do not use answer sheet reproductions:** Use only the original answer sheets that we provide—reproductions will not work with our scanning equipment and cannot be processed.

Follow the instructions for marking your answers on the answer sheet. Be sure that blocks 1, 2, and 3 are filled in correctly. This information is necessary for your course to be properly processed and for you to receive credit for your work.

## COMPLETION TIME

Courses must be completed within 12 months from the date of enrollment. This includes time required to resubmit failed assignments.



## **PASS/FAIL ASSIGNMENT PROCEDURES**

If your overall course score is 3.2 or higher, you will pass the course and will not be required to resubmit assignments. Once your assignments have been graded you will receive course completion confirmation.

If you receive less than a 3.2 on any assignment and your overall course score is below 3.2, you will be given the opportunity to resubmit failed assignments. **You may resubmit failed assignments only once.** Internet students will receive notification when they have failed an assignment--they may then resubmit failed assignments on the web site. Internet students may view and print results for failed assignments from the web site. Students who submit by mail will receive a failing result letter and a new answer sheet for resubmission of each failed assignment.

## **COMPLETION CONFIRMATION**

After successfully completing this course, you will receive a letter of completion.

## **ERRATA**

Errata are used to correct minor errors or delete obsolete information in a course. Errata may also be used to provide instructions to the student. If a course has an errata, it will be included as the first page(s) after the front cover. Errata for all courses can be accessed and viewed/downloaded at:

<http://www.cnet.navy.mil/netpdtc/nac/neas.htm>

## **STUDENT FEEDBACK QUESTIONS**

We value your suggestions, questions, and criticisms on our courses. If you would like to communicate with us regarding this course, we encourage you, if possible, to use e-mail. If you write or fax, please use a copy of the Student Comment form that follows this page.

## **For subject matter questions:**

E-mail: n315.products@cnet.navy.mil  
Phone: Comm: (850) 452-1001, Ext. 1713  
DSN: 922-1001, Ext. 1713  
FAX: (850) 452-1370  
(Do not fax answer sheets.)  
Address: COMMANDING OFFICER  
NETPDTTC (CODE N315)  
6490 SAUFLEY FIELD ROAD  
PENSACOLA FL 32509-5000

## **For enrollment, shipping, grading, or completion letter questions**

E-mail: fleetservices@cnet.navy.mil  
Phone: Toll Free: 877-264-8583  
Comm: (850) 452-1511/1181/1859  
DSN: 922-1511/1181/1859  
FAX: (850) 452-1370  
(Do not fax answer sheets.)  
Address: COMMANDING OFFICER  
NETPDTTC (CODE N331)  
6490 SAUFLEY FIELD ROAD  
PENSACOLA FL 32559-5000

## **NAVAL RESERVE RETIREMENT CREDIT**

If you are a member of the Naval Reserve, you will receive retirement points if you are authorized to receive them under current directives governing retirement of Naval Reserve personnel. For Naval Reserve retirement, this course is evaluated at 3 points. (Refer to *Administrative Procedures for Naval Reservists on Inactive Duty*, BUPERSINST 1001.39, for more information about retirement points.)

## **COURSE OBJECTIVES**

In completing this nonresident training course, you will demonstrate a knowledge of the subject matter by correctly answering questions on the following subjects: upper air observations, bathythermograph observations, aviation weather codes, surf observations, plotting radiological fallout and chemical contamination coverages.



## Student Comments

**Course Title:** Aerographer's Mate, Module 2—Miscellaneous Observations and Codes

**NAVEDTRA:** 14270 **Date:** \_\_\_\_\_

**We need some information about you:**

Rate/Rank and Name: \_\_\_\_\_ SSN: \_\_\_\_\_ Command/Unit \_\_\_\_\_

Street Address: \_\_\_\_\_ City: \_\_\_\_\_ State/FPO: \_\_\_\_\_ Zip \_\_\_\_\_

**Your comments, suggestions, etc.:**

<p><b>Privacy Act Statement:</b> Under authority of Title 5, USC 301, information regarding your military status is requested in processing your comments and in preparing a reply. This information will not be divulged without written authorization to anyone other than those within DOD for official use in determining performance.</p>
--

NETPDTC 1550/41 (Rev 4-00)



# CHAPTER 1

## UPPER-AIR OBSERVATIONS

### INTRODUCTION

In this chapter, we discuss the different types of upper-air observations in addition to the primary upper-air observation equipment used by the Navy and Marine Corps. We also discuss how to identify information in the various upper-air code forms. Finally, we discuss the TEMP and PILOT codes that are used to disseminate upper-air observation data and the records that are maintained for each observation.

### UPPER-AIR OBSERVATIONS

---

*LEARNING OBJECTIVES:* Recognize the uses of upper-air observation data. Identify the different types of upper-air observations. Determine which types of upper-air observations are conducted by Navy and Marine Corps observers. Identify the publications that govern upper-air observations and observation codes.

---

During an upper-air sounding, special instruments measure different atmospheric elements in the lower two layers of the atmosphere. These layers are the troposphere and the stratosphere (fig. 1-1). A meteorological transmitter, known as a radiosonde, is attached to a balloon and is tracked by ground equipment. The radiosonde contains sensors that transmit pressure, temperature, and relative humidity data to a receiver as the balloon ascends into the atmosphere. Wind information can also be determined by tracking the balloon's movement via radio signal or optically. The information is processed, encoded, and then transmitted over automated weather networks. Upper-air observations are often referred to as upper-air soundings.

The National Weather Service, U.S. Air Force, and the U.S. Navy's meteorological and oceanographic forecast centers run primary upper-air forecast programs twice a day based on data received from the 0000Z and 1200Z upper-air soundings. The computer programs can use data up to 12 hours old. All observations, regardless of the observation time, are

used if received within 12 hours after the observation. Additionally, all transmitted observations, even those not used in forecasting programs, are automatically entered in the upper-air climatic data base at the National Climatic Data Center in Asheville, North Carolina. This data is used extensively in atmospheric research.

Locally, upper air observations provide an immediate vertical profile of the atmosphere and are invaluable as a forecast tool, particularly for severe weather and general aviation forecasts.

### NAVY/MARINE CORPS UPPER-AIR PROGRAMS

Upper-air observations are conducted aboard many naval ships and at many naval and Marine Corps stations. Aircraft carriers (CVs) and most amphibious ships (LCC, LHA, LHD, LPHs) routinely conduct upper-air observations primarily for operational support. This support includes weather forecasts as well as refractivity forecasts. Some sites located on islands or in remote areas are designated Synoptic Upper-air Observation Sites. These activities routinely conduct upper-air observations to support World Meteorological Organization (WMO) data collection requirements, as well as operational commitments. Mobile Environmental Teams (MET) use portable equipment aboard ship and at remote shore sites to conduct upper-air observations in support of operational and research requirements. Marine Corps Meteorological Mobile Facility (MMF) members also use portable equipment and meteorological vans to conduct upper-air observations to support forces on temporary deployments.

Normally, all upper-air observations from ships, designated Synoptic stations, and remote land locations are encoded and transmitted. Special observations conducted for training at shore stations may be encoded but are not usually transmitted.

**NOTE:** In this chapter, we use *altitude* and *height* only by the strictest definition: *height* is the vertical measurement or approximation above the ground level (AGL); *altitude* is the vertical measurement or approximation above mean sea level (MSL). Most

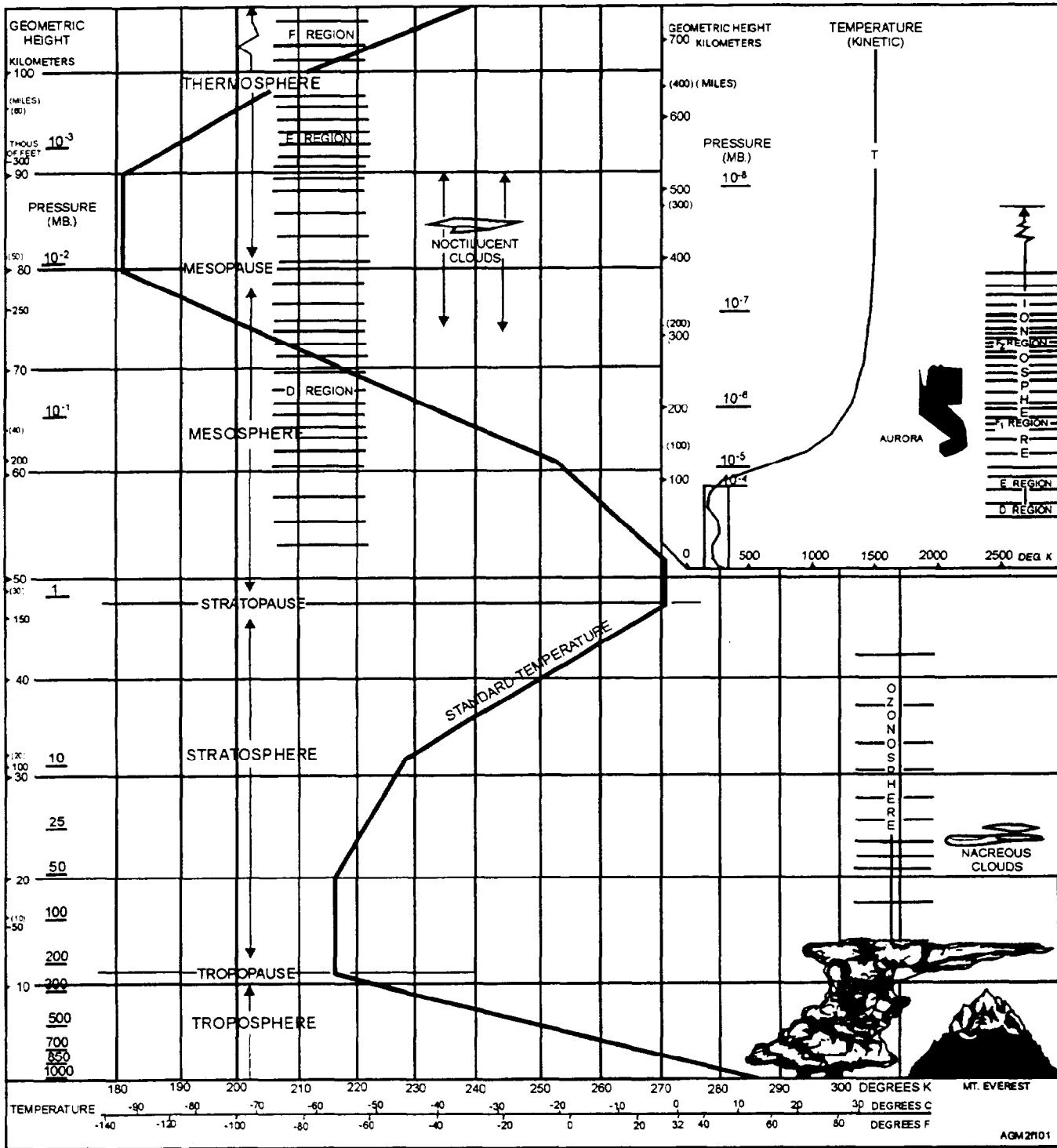

Figure 1-1.—Earth's atmospheric layers.

encoded and reported "heights" in upper-air observations are actually altitudes.

### TYPES OF UPPER-AIR OBSERVATIONS

The term *upper-air observation* may be applied to any of the different types of observations conducted to

measure the temperature, humidity, pressure, and/or wind speed and wind direction at various levels above earth's surface. The terms *RAOB* (*RA*dio*sonde* *O*bservation) and *RAWIN* (*RA*W*IN*sonde observation) are frequently used to refer to type of upper-air observation. In the past, Navy and Marine Corps

observers conducted several types of upper-air observations:

- *Radiosonde observations:* Pressure, temperature, and humidity measured by a balloon-borne instrument. Data is transmitted in the TEMP, TEMP MOBIL, or TEMP SHIP code.

- *Rawinsonde observations:* Pressure, temperature, and humidity measured by a balloon-borne instrument. Wind speed and direction may be obtained from a ground-based directional-tracking antenna homing in on the radiosonde's transponder. Winds are also calculated by using remote Very Low Frequency (VLF) signals or by the satellite Global Positioning System (GPS). Collected data is disseminated in the TEMP, TEMP MOBIL or TEMP SHIP code, with selected information distributed in the PILOT, PILOT MOBIL, or PILOT SHIP code.

- *RABAL observations (RAdiosonde BALloon):* These observations measure wind speed and direction by using a theodolite or a fire-control radar to track a reflector attached to a radiosonde train. When conducted in conjunction with a RAOB, data is distributed in the TEMP, TEMP MOBIL, or TEMP SHIP code. When only wind information is obtained, data is distributed in the PILOT, PILOT MOBIL, or PILOT SHIP code.

- *PIBAL observations (PIlot BALloon):* A balloon is tracked with an optical theodolite (or radar) to determine only low-level wind speeds and directions. No radiosonde is attached to the balloon. Heights are based on assumed ascension rates. When transmitted, data is encoded in PILOT, PILOT MOBIL, or PILOT SHIP code.

With the introduction of compact, computerized rawinsonde systems containing navigational aid (NAVAID) receivers in the mid 1980's, the Radiosonde and Rabal observations became obsolete. Pibal observations are still conducted by Marine Corps observers in the field to provide low-level wind observations in support of aviation operations and paratrooper operations. Pibal observations are particularly important in situations where radio emissions would lead to detection by enemy forces.

Throughout the world, other countries conduct and transmit data from Radiosonde, Rawinsonde, Rabal, and Pibal observations. Several countries, including the United States, routinely carry out additional types of upper-air observations as follows:

- *Rocketsonde observations:* A rocket containing pressure, temperature, and wind sensors is launched from a ship, land station, or aircraft. After the rocket reaches apogee, the instrument package, deployed on a parachute, measures the atmosphere as it descends. Observed data is transmitted in the ROCOB code.

- *Dropsonde observations:* Aircraft deploy a parachute-carried sensor package; the sensors measure pressure, temperature, humidity, and winds. This information is transmitted in TEMP DROP code.

- *Aircraft flight level observations:* Aircraft flying routine flight levels may contain an automatic sensor unit that measures, encodes, and automatically transmits an Aircraft Meteorological Data Relay (AMDAR) message, which contains pressure, temperature, dew point, and wind information. Similar data may be gathered manually by the aircrew from onboard equipment and forwarded by voice radio or commlink in the CODAR code.

## UPPER-AIR OBSERVATION PUBLICATIONS

All U.S. upper-air observations, including military, are governed by procedures outlined in the Federal Meteorological Handbook No. 3 (FMH-3), *Rawinsonde and Pibal Observations*. The FMH-3 prescribes federal standards for conducting Rawinsonde and Pibal observations, and for processing, encoding, transmitting, and archiving observation data. Also provided are procedures for quality control.

All information in the FMH-3 is consistent with World Meteorological Organization (WMO) standards. WMO publication number 306, Manual on Codes, Volume 1, *International Codes*, contains a complete breakdown of all upper-air observation code forms.

The following text discusses the Mini Rawinsonde System (MRS).

## REVIEW QUESTIONS

- Q1. *Upper-air observations measure what two layers of the atmosphere?*
- Q2. *Which atmospheric elements does a radiosonde measure?*
- Q3. *What are the main uses of upper-air observation data?*

- Q4. What is the significant difference between a radiosonde observation and a rawinsonde observation?
- Q5. What are the two types of upper-air observations still conducted by Navy and Marine Corps personnel?
- Q6. An aircraft deployed radiosonde is known by what term?
- Q7. What publication outlines procedures for all United States civilian and military upper-air observations?

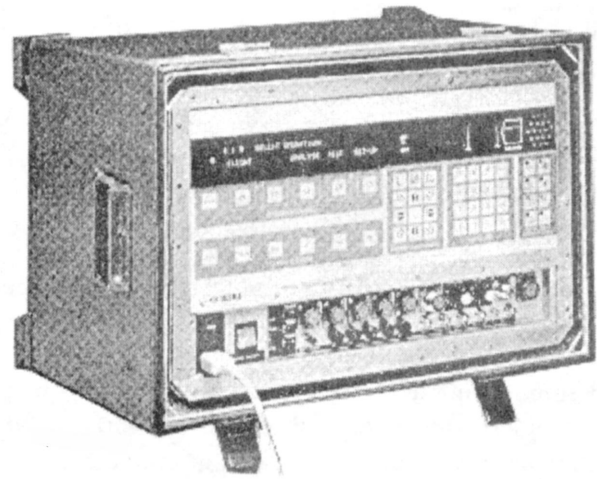

Figure 1-2.— AN/UMQ-12 MRS data receiver/processor and case.

### MINI RAWINSONDE SYSTEM

**LEARNING OBJECTIVES:** Describe the procedures used to conduct an upper-air observation using the Mini Rawinsonde System (MRS). Explain the correct balloon preparation procedures. Identify the modifications that must be made to the MRS-evaluated data to conform to WMO international and regional coding requirements, as well as national requirements.

The AN/UMQ-12 mini rawinsonde system (MRS) is a highly compact, portable system ideal for shipboard, mobile team, and field use. It consists of a relatively lightweight (66-pound) computerized receiver/processor (fig. 1-2) mounted in a rugged, shock-absorbing case. The system also includes an RM-20 UHF telemetry antenna that receives data signals from the Vaisala RS-80 radiosonde transmitter, which is carried aloft by the balloon (fig. 1-3). Most MRS units are now equipped with a GPS antenna that is

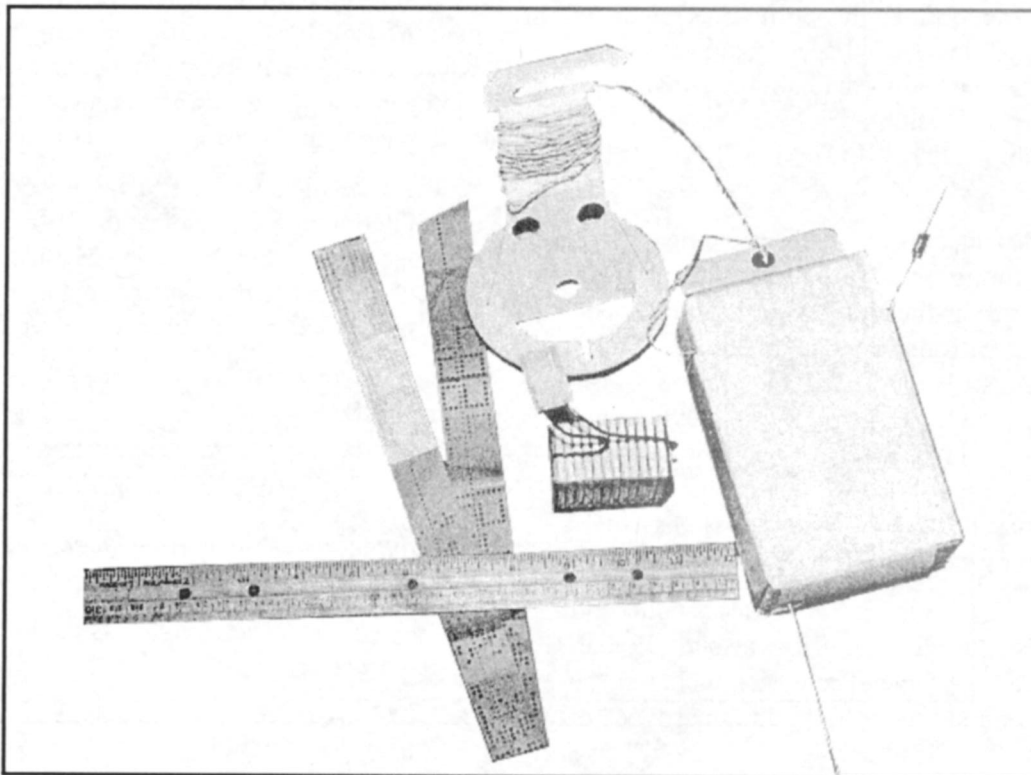

Figure 1-3.—Vaisala RS-80 series radiosonde instrument.



used to determine wind vector information from the radiosonde. Units without GPS use a VLF antenna to monitor reception of the OMEGA network NAVAID signals, which can be used to determine the same information. A printer is also included in the system.

The receiver can operate in nearly any environment on 110V or 220V alternating current, or on 24V direct current. However, make sure you keep the system sheltered from precipitation while in use. The VLF and UHF antennas should be mounted at least 8 feet apart. If working aboard ship, mount the antennas as high on the ships superstructure as possible, while avoiding radar

antennas and other transmitters. In addition to equipment listed, a computer may be connected to the MRS for direct download of observation data to diskette. Data disks are then forwarded to the Fleet Numerical Meteorology and Oceanography Detachment (FNMOD), Asheville, North Carolina, for archiving. Figure 1-4 shows the overall operating scheme of the system.

### MRS OPERATION

Operation of the AN/UMQ-12 is very simple and is detailed in the operator's manual, MWOP-00139-3.2,

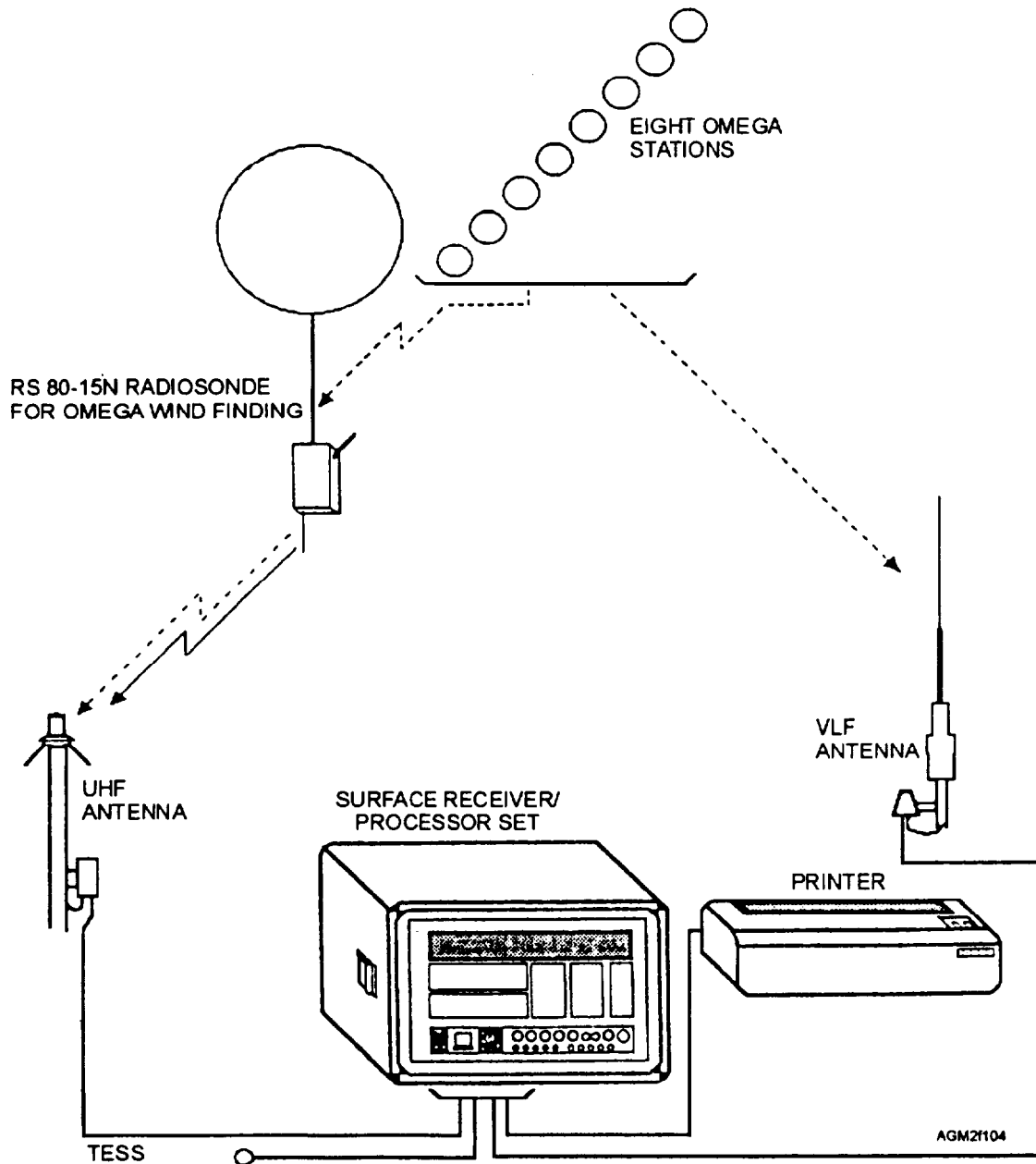

Figure 1-4.—MRS system diagram (VLF-Omega).

*Mini Rawin System Operating Procedure*, and the MARWIN MW 12, User's Guide. The display panel prompts the operator for input. The equipment should be left in the standby mode except when no soundings are to be taken for several days or when the system is to be moved. The system will automatically run self-diagnostic checks (after a brief warm-up period) when initially powered up. After self-diagnostics, the equipment will display the date and time (UTC). Initial setup parameters, such as station elevation, latitude/longitude, etc., must be entered by using the "SYSGEN" function. Operation control keys "CMND" and "C1" through "C5" are used to initiate or terminate data sequences. The LCD window directly above the operation control keys identifies the function of each key during each particular sequence. The data entry keypad is used to manually enter data.

To conduct an upper-air sounding, the operator normally runs through the following sequence, which is detailed in the operator's manual:

1. Preparation of the balloon
2. Preparation of the rawinsonde instrument and battery
3. Entry of rawinsonde calibration data
4. Rawinsonde telemetry and receiver check
5. GPS/NAVAID system signal reception check
6. Connection of rawinsonde instrument to balloon
7. Obtain release authorization
8. Balloon release (system automatically starts)
9. Surface weather observation and entry of data
10. Entry of termination data
11. Print out coded upper-air messages or data as desired (or download to diskette)

## **BALLOON PREPARATION**

Preparation of the balloon is not covered in the MRS operator's manual. Certain aspects of balloon storage, handling, and release procedures are covered in the Federal Meteorological Handbook Number 3.

Meteorological balloons are spherical films of synthetic rubber (neoprene) that, when inflated with a lighter-than-air gas (helium or hydrogen), rise into the upper atmosphere. Sizes of balloons vary by application, but all are measured by the weight of the neoprene used to make the balloon. Meteorological

balloons are extremely thin. The rubber is from 0.002- to 0.004-inch thick when inflated for release, but decreases to less than 0.00001 inch at bursting altitude. To state it more graphically, the balloon at release is thinner than an ordinary piece of writing paper, and decreases to 1/200th to 1/400th of its original thickness at altitude- a mere film of rubber. It is not hard to see that the smallest cut, bruise, or scratch sustained during preflight preparation is almost sure to cause the balloon to burst at a lower altitude. Careful preflight handling of these balloons is mandatory. Although meteorological balloons come in 100-, 300-, 600-, and 1200-gram sizes, we will consider only the 100-gram and 300-gram balloons.

The 100-gram neoprene balloons are recommended for normal MRS soundings and should be used during high-wind conditions. The 300-gram neoprene balloons are better suited for higher flights. Shipboard and MET users report average MRS soundings to the 130-hPa pressure level (about 48,000 feet) using unconditioned 300-gram balloons, and average flights to the 300- to 250-hPa level (32,000 feet) using unconditioned 100-gram balloons. However, the RS-80 series rawinsondes are designed for soundings in excess of 30 kilometers (well above the 25-hPa level) and routinely ascend above that altitude at most synoptic locations.

Balloons should be stored in their original sealed containers in a room isolated from large electric motors or generators. Motors and generators emit ozone, which is detrimental to neoprene. Ideal temperature for storage would be in the range of 10°C/50°F to 30°C/85°F. Temperatures below freezing and above 50°C/120°F should be avoided during storage. Balloons deteriorate with age; they should be used in the order of their production dates to avoid excessive aging. If by necessity balloons are stored at temperatures below freezing, they should be removed to a room having temperatures of 18°C/65°F or higher for at least 12 hours before use, to avoid any damage that would result if they were removed from the container and unfolded when cold. The balloons are extremely delicate, especially when softened by conditioning. No part of the balloon except the neck should be touched with bare hands. Use soft rubber gloves or soft cotton gloves, or use the plastic bag in which the balloon was received as a glove to handle any portion other than the neck of the balloon.

## Balloon Conditioning

As a result of exposure to relatively low temperatures or extended storage, neoprene balloons lose a portion of their elasticity through crystallization. Balloons in this condition will burst prematurely. Conditioning the balloons restores their elasticity and helps ensure higher flights. Balloon conditioning should be done to all balloons more than 1 year old or that have been stored in cold temperatures. For Navy and Marine Corps observations, balloons may be conditioned by immersing the balloon in boiling or nearly boiling water for 5 minutes.

## Balloon Inflation

Proper balloon inflation procedures are not published for the MRS system. The 100-gram and 300-gram balloons must be inflated so that the ascension rate keeps the MRS system active. Slower ascension rates may be interpreted as a leaking balloon, and the system will terminate the sounding. Faster ascension rates prevent accurate data sampling and may also result in automatic sounding termination by the receiver. The ideal ascension rate for a balloon is between 900 feet per minute and 1,000 feet per minute.

**INFLATION GASES.**—Helium is the safest lighter-than-air gas for use in inflating meteorological balloons. It is inert and will cause no fire, explosion, or health problems. Hydrogen or natural gas can be used in an emergency if helium is not available, but both gases are explosively flammable and pose serious safety hazards. Their use is not recommended. The AN/TMQ-3 hydrogen generator set has been used at some remote upper-air sites to produce hydrogen gas locally.

Two types of helium may be used to inflate balloons: oil-free and oil-pumped helium. Oil-free helium is supplied in metal compressed-gas bottles that are about 4.5-feet high; the bottles are painted gray, with the top portion of the bottle and valve cover painted yellow or brown. Since this gas is not hazardous to health, the bottle connection is a standard screw thread.

Oil-pumped helium, however, contains more contaminants than oil-free helium, and may cause health problems if breathed. These cylinders are painted gray with an orange band around the cylinder, and the cylinder connection has a reverse-screw thread.

The standard pressure-reducing helium regulator (fig. 1-5) is usually painted bright orange, and is used to regulate the flow of gas into the balloon. The regulator

is attached to the oil-free helium bottles with an adaptor (on the chain). The indicator dial nearest the cylinder connection indicates total pressure in the helium cylinder (normally 2,000 psi when full) on the outer scale, and cubic feet of helium (220 cubic feet when full) on the inner scale.

The second indicator dial shows the low-pressure flow to the regulator outlet. The low-pressure flow is adjusted by turning the T-handle on the valve body; turning the T-handle clockwise shuts off the flow. Before the regulator is removed from the cylinder, the helium cylinder valve must be closed and the pressure bled from the regulator. A low-pressure hose is not supplied with the regulator. Several suitable low-pressure hoses are available through the supply system, but you may use a clear plastic, 3/8-inch-diameter hose that is lightweight and flexible. Use screw clamps to connect the hose from the regulator nipple to the inflation nozzle. Helium flow should be set during inflation at about 15 psi on the low-pressure gauge. Inflating balloons at higher settings will inflate the balloon too rapidly and stress the neoprene, resulting in premature balloon failure. Flow of gas into the balloon is controlled by the on/off valve on the weighted balloon nozzle.

**INFLATING BALLOONS.**—The ideal ascension rate for a 100-gram or 300-gram balloon is 900 to 1,000 feet per minute. This rate is achieved by inflating the balloon to neutral buoyancy (the balloon will neither rise nor sink on its own) while attached to an inflation nozzle weighted from approximately 600 to 1,000 grams (1.3 to 2.2 pounds). Before release, the weighted nozzle is removed and the 250-gram MRS RS-80 series rawinsonde instrument is attached to the balloon. A 100-gram balloon should have a free lift of about 600 to 800 grams, and a 300-gram balloon should have a free lift of between 800 to 1,000 grams.

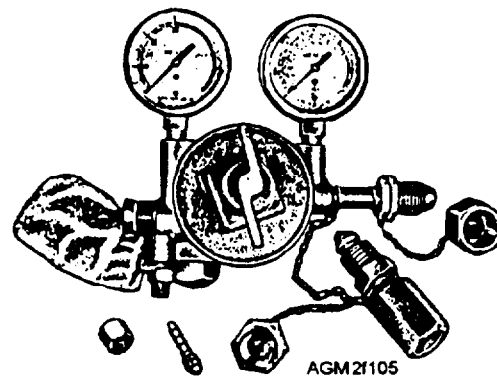

Figure 1-5.—Standard pressure-reducing helium regulator.

To inflate a balloon, hold the inflation hose 2 to 3 inches from the connection to the balloon nozzle and allow the gas to flow into the balloon until the balloon just supports the weight of the inflation nozzle assembly (to achieve neutral buoyancy). It is a good idea to shut off the valve when the balloon is about half-full and listen for any leaking air from holes that may be in the balloon. Finally, shut off the gas flow and tie off the balloon.

If balloon inflation weights are not available, balloons may be inflated using only the regulator. You may inflate the balloons with the required amount of gas by using the inner (cubic feet) scale of the high-pressure dial. To achieve approximately 700 grams of free lift, a 100-gram balloon will take about 40 cubic feet of helium. To achieve 900 grams of free lift, a 300-gram balloon will need about 70 cubic feet of helium. In any case, the balloon should produce a fairly strong pull or tug on the nozzle and hose.

#### **ADJUSTMENTS TO INFLATION.—**

Ascension rates should be calculated for all soundings. Because of environmental conditions, free lift weight is adjusted to better target the 900 to 1,000 feet per minute desired ascension rate. During precipitation or icing, you must increase the free lift to compensate for the additional weight of water, snow, or ice on the balloon. For example, during light rain or drizzle, you must increase free lift (weight of inflation nozzle assembly) by 100 grams or increase the helium in the balloon by 3 to 4 cubic feet. When light to moderate icing or moderate to heavy precipitation is anticipated, increase the free lift by 200 to 300 grams or increase the helium by 7 to 11 cubic feet. However, increasing the free lift by more than 300 grams during severe icing conditions may slow the ascent rate because of the increased surface area on which ice may collect.

#### **Tying the Balloon**

After inflation, it is imperative that the balloon neck be tied properly to prevent leakage of gas and to allow for attachment of the instrument. Most balloons can be sealed by using a single loop over the unwinder gripper and a plastic tie. If no plastic ties are available, use a 3- to 4-foot length of cotton textile tape (balloon tape) or a medium thickness cotton twine. Fold the twine in half to obtain a double thickness. While the balloon is still on the inflation nozzle, tie a tight square knot around the balloon neck about 1 1/2 to 2 inches below the body of the balloon. Remove the balloon from the nozzle and loop the excess balloon neck up and over the first knot by about an inch. Then, wrap the loop tightly with the remaining cord ends, and tie it securely with a second

square knot. The loop in the balloon neck must be large enough to insert the gripper of the balloon winder through the loop (fig. 1-6). The remaining excess cord is used to handle the balloon before release. The balloon cord should be attached to the unwinder gripper with a double square knot prior to release. Tying the cord to the gripper will help prevent the gripper from chaffing the balloon loop during gusty wind conditions. Allow no more than 6 to 8 feet of train from the unwinder.

#### **Use of Parachutes**

Parachutes are neither required nor recommended for use during an MRS sounding. The 250-gram RS-80 series radiosonde instrument, even when in free-fall after balloon burst, has sufficient drag that even a direct strike to a person on the ground will cause no serious injury. However, the National Weather Service does require their use. If a parachute is elected for use at land stations, the parachute is tied to the balloon, and the radiosonde is affixed to the bottom of the parachute. Use of the 6-foot paper parachute or the 6-foot cloth parachute requires that an extra 100 grams be added to the nozzle weight during Inflation to maintain proper free lift. Meteorological parachutes are never used at sea.

#### **Use of Balloon Shrouds**

A balloon shroud is recommended for use to protect and securely hold or move the balloon and radiosonde prior to launch during windy conditions. The fabric balloon shroud may be used to hold balloons up to 7 1/2 feet in diameter. When moving a balloon, use the handles at the corners of the shroud. The cloth bands at the apex of the shroud may be used to attach an anchoring line, which is used to pull the shroud off the balloon as the handles are released during launch. Balloon shrouds must be hung to dry if used during rain, and must contain an antistatic electricity treatment if used with hydrogen or natural-gas-filled balloons.

#### **REVIEW QUESTIONS**

- Q8. *What is the purpose of the GPS antenna?*
- Q9. *What are the two most widely used gases for meteorological balloons?*
- Q10. *What are the two most commonly used meteorological balloons sizes?*
- Q11. *What is the only part of the balloon that should be touched?*

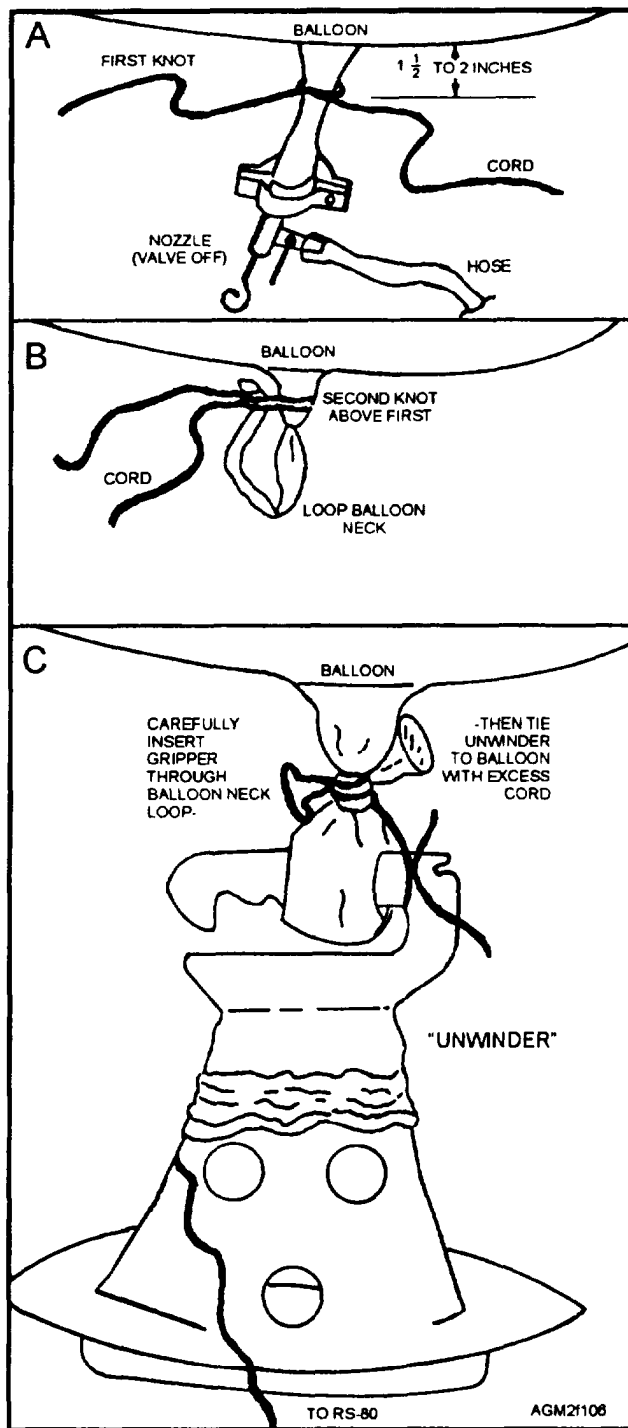

Figure 1-6.—Tying the balloon neck to hold the radiosonde instrument: (A) First square knot, (B) looping the balloon neck and tying the second square knot above the first, and (C) attaching the unwinder to the balloon and tying unwinder to balloon with excess cord.

Q12. Under what circumstances should a meteorological balloon be conditioned before use?

Q13. What is the ideal ascension rate for a meteorological balloon?

Q14. What is the purpose in using a gas regulator?

Q15. How much cubic feet of helium is required to achieve a free lift of 700 grams when using a 100-gram balloon?

Q16. What must be done to the balloon when conducting upper-air observations during periods of precipitation or icing?

Q17. At sea, when is a parachute required to be attached to the radiosonde?

Q18. What is the purpose of a balloon shroud?

### PREPARATION OF THE RADIOSONDE

The lightweight, Vaisala RS-80 radiosondes are unpacked from the protective envelopes and readied for flight according to following the instructions provided in the operator's manual. An 18-volt battery is activated by immersion in room-temperature tap water for 3 minutes. After lightly shaking off the excess water, the battery is then plugged into the instrument to activate the radiosonde. The radiosonde instrument is automatically set to 403 MHz, but may be tuned from 400 to 406 MHz to avoid local interference. A small screw located on the outside of the radiosonde can be turned by using a small screwdriver to adjust the frequency up or down.

The radiosonde should be placed outside, out of direct sunlight and hot surfaces (decks/stacks), for five minutes. This allows the sensors in the radiosonde to stabilize prior to launch. Keep in mind that if the battery is left to sit for more than 20 minutes, it may overheat and become unstable, so time management of prelaunch procedures is essential. Be sure to remove the plastic cover from the sensor strip prior to releasing the radiosonde.

### ENTRY OF CALIBRATION DATA

Each RS-80 radiosonde instrument is precalibrated during manufacture and is supplied with a calibration punch-tape. When each upper-air sounding is initiated, the system prompts the operator to enter the calibration punch-tape in the optical reader slot. This will ensure that the signals received from the radiosonde are properly interpreted by the system. The calibration

coefficients printed on the nonperforated strip attached to the punch-tape may also be entered manually.

### **TELEMETRY AND RECEIVER CHECK**

The receiver may be retuned to the radiosonde, following the procedures in the operator's manual, and the wide-band or narrow-band receiver mode selected. The wide-band mode is always used unless locally produced radio interference requires use of the narrow-band mode. Normally, both the radiosonde and the receiver should be retuned, to try to avoid the interference before selecting the narrow-band mode. The best reception of the radiosonde is indicated by five asterisks in the reception LCD window, with fewer asterisks indicating weaker reception. The absence of any asterisks indicates the signal is about to be lost.

### **NAVAID SYSTEM SIGNAL RECEPTION CHECK**

Navigation-aid radio signal strength from the eight Omega stations are checked following procedures listed in the operator's manuals. If the receiver or transmitter is, or will move to within 60 nautical miles of one of the NAVAID transmitter sites, the receiver/processor will not process the signal properly and could cause incorrect wind data. The station must be deleted from the program before the sounding begins. Use the "SYSGEN" program edit mode as described *in* the operator's manual to delete a nearby Omega station. Upgraded MRS units and radiosondes use GPS, which is more reliable and accurate than the VLF-Omega system.

### **RELEASE AUTHORIZATION**

After the instrument checks have been completed and the radiosonde is attached to the balloon, the operator must contact the air traffic controller in the shore-station control tower to obtain "permission to release a meteorological balloon." The air traffic controllers are responsible for transmitting any NOTAMs (Notice To Airmen) that may be required at Naval and Marine Corps air stations. Aboard ship, the operator must contact the officer of the deck (OOD) for permission to release a meteorological balloon. The OOD has the responsibility for contacting the Tactical Action Officer (TAO), the shipboard air traffic controllers, and the Air Boss to obtain release authorization, and then to relay the authorization to the observer. Since the shipboard process involves several different departments, each of which may be extremely busy with normal ship handling and flight-quarters evolutions, it is best to obtain authorization well before release time. Keep in mind that certain electronic

emissions control (EMCON) restrictions may preclude a radiosonde launch.

### **SURFACE WEATHER OBSERVATION**

Just before release of a meteorological balloon, a weather observation must be made. Data from the surface weather observation is entered into the receiver/processor either before or after release, but before the radiosonde instrument has passed the 14,000-foot height. The surface observation data entry routine will prompt the operator to enter the station pressure in whole hectopascals, the air temperature to the nearest 1/10 Celsius degree, the relative humidity to the nearest percent, true wind direction to the nearest degree, wind speed to the nearest knot, and the cloud group  $N_h C_L h C_M C_H$ , as described later in this chapter.

The surface observation data should be compared to the surface raw data received from the radiosonde and displayed by the computer. If the comparison values are outside the range plus or minus 1°C for temperature and 10% relative humidity, the radiosonde should be allowed to acclimate an additional 5 minutes. If the radiosonde fails this check, another radiosonde should be used.

### **BALLOON RELEASE**

When the balloon is released, the radiosonde reports a decrease in pressure to the data processor, which automatically starts the data recording and processing function. Data will print out or be transmitted to a computer 8 to 10 minutes after release. During ascent through the first 15,000 feet, the radiosonde instrument is most susceptible to interference and loss of NAVAID/GPS signals used to determine winds. To determine accurate winds, the receiver should be maintained continuously in the "track" mode during this time.

### **REVIEW QUESTIONS**

- Q19. How are RS-80 radiosondes powered?*
- Q20. How can the radiosonde frequency be adjusted?*
- Q21. How is high quality reception indicated by the MRS?*
- Q22. Aboard ship, what person authorizes the release of a radiosonde balloon?*
- Q23. What should be done with the surface observation data before a radiosonde is released?*

## EVALUATION OF INFORMATION

Data is continuously monitored by the data processor during the sounding, with significant levels for temperature, humidity, and winds selected by the computer. The radiosonde readings will automatically print out in 5-second intervals in the first few minutes of the sounding, as shown in table 1-1, and then change to 10-second intervals.

All data are automatically processed. An increase in pressure is interpreted as a balloon burst, and the sounding will automatically terminate. Failure of the pressure to decrease is interpreted as a "floating balloon," and this will also terminate the sounding. Other factors that will cause sounding termination are pressure values missing for more than 10 minutes, temperature data missing for more than 8 minutes, and humidity data missing for more than 6 minutes. Manual termination of the sounding may be made via the command entry keys.

### CAUTION

Pressing the "reset" command at any time will completely dump all sounding data and reset the program to the beginning of the set-up routine.

All U.S. synoptic upper-air sites are required to launch a second radiosonde should the first radiosonde fail to reach a height of at least 400 hPa. Navy and Marine Corps upper-air soundings conducted for operational support are exempt from this requirement. All raw data printed out during the flight should be scanned for validity. Continuous output of erroneous data will obviously necessitate another launch. Any periods of doubtful data should be encoded as such on the transmitted message. Prolonged periods of doubtful or missing pressure, temperature, humidity, or wind data may also invalidate the sounding. Criteria is outlined in chapter 3 of the FMH-3.

After the sounding is terminated, the system may be directed to print a listing ("LIST" program) of significant levels (table 1-2), which were selected by the computer for changes in temperature, humidity, or winds, and a listing of all mandatory levels (table 1-3). In addition, the "TEMP" program will produce a printout of the TEMP coded report (table 1-4). Abbreviations on the significant level printout indicate the reason the level was selected, such as *T* for temperature, *U* for relative humidity, *TR* for tropopause, *F* for wind speed, *D* for wind direction, and *MV* for maximum wind

Table 1-1.—MRS Sounding Automatic Data Printout

Start Up Date 10 AUG 97 11:25 GMT										
System test passed - No errors found										
Sounding program REV 7.10 with Omega windfinding										
Station : 02313										
Location : 60.28 N 24.88 E 28 m above mean sea level										
RS-number : 042873251										
Started at : 10 AUG 97 11:48 GMT										
Time	Hgt/MSL	Pressure	Temp	R H	Dew p	R I	MRI	Hgt/MSL	Dir	Speed
min s	m/MSL	hPa	degC	%	degC			ft/MSL	deg	k t s
0 0	0	996.4	11.3	87	9.2	325	325	0	307	2.2
0 5	33	992.4	11.1	84	8.5	322	327	108	267	14.0
0 10	63	988.8	10.9	82	8.0	319	329	207	267	14.0
0 15	92	985.4	10.7	81	7.6	317	332	302	267	14.2
<b>NOTE:</b> Printout continues - every 5-10 seconds until end of sounding, @90 minutes										

Table 1-2.—MRS Significant Levels Printout (LIST)

Time min s	Hght gpm	Press hPa	Temp C	Hum %	T d C	R I	M R I			
0 0	0	996.4	11.3	87	9.2	325	325	T	U	
1 30	510	936.9	6.8	94	5.9	303	383	T		
6 35	2367	743.5	-5.7	95	-6.4	235	607		U	
6 50	2465	734.3	-5.9	77	-9.3	229	616		U	
7 55	2878	696.4	-9.1	96	-9.6	220	672		U	
12 35	4657	550.5	-20.8	79	-23.5	175	906	T		
12 55	4779	541.4	-21.9	83	-24.0	172	923		U	
14 20	5314	503.2	-26.0	58	-31.9	161	995		U	
21 30	8000	340.7	-49.6	54	-54.9	119	1375		U	
21 50	8135	333.7	-50.6	52	-56.2	117	1394	T		TR
23 35	8893	297.0	-51.7	21	-64.4	104	1500		U	
24 10	9166	284.8	-51.8	18	-65.7	100	1539	T		
26 0	9921	253.8	-46.4	3	-74.1	87	1644	T		
26 30	10125	246.1	-46.6	1	-81.4	84	1674		U	
29 25	11364	204.4	-43.9	1	-79.5	69	1853	T		
42 0	16117	100.0	-47.1	1	-81.8	34	2565	T	U	
48 30	18494	67.7	-50.5	1	-84.1	24	2928	T		TR
51 45	19719	57.8	-49.0	1	-83.1	20	3116	T		
54 15	20677	49.9	-52.8	1	-85.8	18	3264	T		
55 50	21277	45.5	-49.9	1	-83.7	16	3356	T		
58 10	22194	39.5	-53.3	1	-85.4	14	3498	T		
60 5	22943	35.2	-51.5	1	-84.8	12	3614	T	U	
Time mins s	Hght gpm	Press hPa	dd deg	ff kts						
0 0	0	996.4	307	2.1	F	D				
0 5	33	992.4	267	14.0	F	D				
5 45	2037	775.4	281	10.3		D				
8 0	2908	693.7	252	8.7		D				
11 35	4276	579.4	254	11.1		D				
14 50	5487	491.3	185	9.3		D				
19 20	7135	388.1	155	6.0		D				
20 5	7419	371.9	162	5.4		D				
21 25	7963	342.6	212	4.5	F					
21 45	8100	335.5	226	4.9		D				
23 35	8893	297.0	263	10.9		D				
25 40	9787	259.0	281	23.5	F					
42 0	16117	100.0	270	31.3	F	D				
60 5	22943	35.2	284	18.5	F	D				



**Table 1-3.—MRS Mandatory Levels Printout (LIST)**

Press hPa	Hght gpm	Temp C	Hum %	T d C	d d deg	f kts	R I	MRI
1000.0	431	//////	///	//////	///	////	///	////
925.0	606	6.1	95	5.2	273	13.0	298	395
850.0	1303	1.5	85	-0.7	277	15.4	268	395
700.0	2837	-8.8	94	-9.6	254	8.6	21	666
600.0	5360	-26.4	58	-32.2	190	9.3	160	1001
400.0	6927	-40.1	50	-46.6	159	6.0	134	1221
300.0	8829	-51.4	23	-63.5	258	10.1	105	1491
250.0	10022	-46.3	2	-76.8	281	24.3	86	1659
200.0	11510	-44.5	1	-80.0	278	29.9	68	1875
150.0	13429	-45.7	1	-80.8	274	32.1	51	2160
100.0	16116	-47.1	1	-81.8	270	31.3	34	2565
70.0	18467	-50.4	1	-84.1	271	30.5	24	2924
50.0	20662	-52.7	1	-85.7	279	24.5	18	3262
30.0	23980	//////	///	//////	///	////	///	////

**Significant Temperature and Humidity Levels**

The following criteria apply to the selection of significant levels for temperature and humidity changes. They are considered mandatory and must be reported whenever observed. The MRS is programmed to automatically select these levels.

- Surface level and the highest level observed
- At least 1 level between 110 and 100 hPa
- Freezing level(s)
- The tropopause
- Bases and tops of all *temperature inversions* (layer in which the temperature increases with height) and bases and tops of all *isothermal layers* (layer in which the temperature does not change with height) that are 30-hPa or more thick and located below 300-hPa level or below the tropopause
  - Bases and tops of all temperature inversions in which the temperature changes by 2.5°C or more below the 300-hPa level or the tropopause
  - Bases and tops of all *humidity inversions* (layer in which the humidity or dew-point temperature

increases with height) in which the relative humidity increases by at least 20% when located below the 300-hPa level or the tropopause

- Bases and tops for all layers thicker than 20 hPa in which temperature or humidity data is missing
- The bases and tops of all layers delineated as doubtful (must be entered manually)

The purpose of selecting significant levels is to ensure that the vertical profile of the atmosphere is accurately represented. When you plot significant levels on a diagram (such as the Skew T, Log P), connecting each plotted temperature and dew-point temperature with a straight line will provide a good representation of the actual temperature and moisture changes in the atmosphere.

The manual rawinsonde system operator must select levels based on the same criteria listed above in addition to other levels outlined in the FMH-3. As previously stated, the MRS automatically selects “mandatory” significant levels and “supplemental” significant levels to ensure that these criteria are met. But the MRS operator must review the selected levels to ensure that the system is operating correctly.

Table 1-4.—MRS Coded Message Printout (TEMP)

UUAA 65121 99603 10249 25004  
99996 11221 30502 00531 // // 92606 06017 27513  
85303 01422 27515 70837 08908 22509 50536 26556 19009  
40693 40157 16006 30883 51562 26010 25002 46381 28024  
20151 44586 28030 15343 45785 27532 10612 47185 27031  
88334 50756 23005

77999=

(8 blank lines)

NNNN

UUBB 65120 99603 10249 25004  
00996 11221 11937 06809 22828 00021 33744 05707 44734  
05934 55696 09105 66551 20927 77541 21921 88503 26156  
99341 49750 11334 50756 22297 51736 33285 51964 44254  
46578 55246 46785 66204 43986 77101 47185  
21212 00996 30502 11992 26514 22775 28010 33694 25009  
44579 25511 55491 18509 66388 15506 77372 16005 88343  
21004 99336 22505 11297 26511 22259 28024 33101 27031

31313 46105 81148 90155 RELEASE HGT: 45 FT.

41414 43322=

(8 blank lines)

NNNN

UDD 65135 99603 10249 25004  
70847 50584 27031 50066 53783 28024  
88697 50584 27031

77999=

(8 blank lines)

NNNN

UDD 6513/99603 10249 25004  
11697 50584 22578 49184 33499 52983 44455 49984 55395  
52383 66352 51583  
21212 11352 28518

51515 10190 30398=

(8 blank lines)

NNNN

(information in italics may be inserted by the operator)

## Significant Wind Levels

Significant levels are also selected for wind changes. When a sounding is evaluated manually, winds are plotted on either the Winds Aloft Graphing Board or the Winds Aloft Plotting Chart. Wind directions are plotted on a direction scale, and wind speeds are plotted on a speed scale. The MRS automatically evaluates winds and selects the proper significant levels. Some stations report Fixed Regional Levels for winds in place of significant wind levels.

**FIXED REGIONAL LEVELS (WIND).** Winds for the *Fixed Regional Levels* (table 1-5) must be reported by all designated Synoptic Stations in WMO Region IV, North America and Hawaii. This is a regional code convention. Current software in the MRS does not evaluate fixed regional levels, so they must be manually selected and encoded. This may be done by manually plotting the observed wind directions, wind speeds, and pressure for each minute of flight on a Winds Aloft Graphing Board or Winds Aloft Plotting Chart at the appropriate altitude. The pressure level, wind direction, and speed may then be determined for each fixed regional level. After the surface level, the first fixed regional level that is reported is the next higher level above the surface. When fixed regional levels are reported, additional significant levels may also need to be considered. In these cases, the MRS-selected significant wind levels are not used.

### SELECTING SIGNIFICANT WIND LEVELS.

Significant level winds are used by ships and MRS-equipped stations that are not required to report fixed regional level winds. The MRS uses the following WMO requirements when selecting significant wind levels:

- The surface and last level of the sounding
- The maximum wind(s)
- Any level of abrupt change in wind speed (greater than 10 knots) or direction
- The terminating wind (last wind speed of the sounding is greater than 60 knots and is the highest wind speed observed)
- Supplemental levels so that plotted wind directions at selected significant levels may be connected with straight lines and no direction (except in layers of winds less than 10 knots) will deviate by more than 10 degrees

**Table 1-5.—Fixed Regional Level Altitudes for Reporting Winds in WMO Region IV**

UP THROUGH 100-hPa		ABOVE 100-hPa	
FEET	METERS	FEET	METERS
surface	0	60,000	18,000
1,000	300	70,000	21,000
2,000	600	80,000	24,000
3,000	900	90,000	27,000
4,000	1,200	100,000	30,000
6,000	1,800	110,000	33,000
7,000	2,100	140,000	42,000
8,000	2,400	150,000	45,000
9,000	2,700	160,000	48,000
12,000	3,600	170,000	51,000
14,000	4,200	180,000	54,000
16,000	4,800	190,000	57,000
20,000	6,000	200,000	60,000
25,000	7,500	etc.	etc.
30,000	9,000		
35,000	10,500		
50,000	15,000		

- Supplemental levels so that plotted wind speeds at selected significant levels may be connected with straight lines and no wind speeds will deviate by more than 10 knots

Stations that report only fixed regional level winds must also select significant level winds based on the criteria above, when applicable.

### Supplemental Information

In addition to time, altitude, pressure, temperature, humidity, dew-point depression, and winds, the level printouts include *RI*, the refractive index in *N* units; and *MRI*, the refractive index in modified or *M* units. The Tactical Environmental Support System (TESS) uses *M*-units as the primary input for refractive effects analysis and forecasts.

## MODIFICATION OF REPORT

### MESSAGE

The MRS coded message is in the proper WMO International code but does not conform to the United States national coding practice with regard to significant level winds. By national coding practice, all fixed and mobile land upper-air stations within the United States do not report significant wind levels, but only include fixed regional level winds. In addition, fixed regional level winds are reported in the PILOT code in message Parts B and D. However, U.S. Navy ships, even though they may be operating within WMO Region IV, report significant winds levels only in Part B of the TEMP code.

U.S. Naval ships may use Additional Data groups, the so-called "101-code groups" (table 1-6), as specified by WMO Region IV practice, even when

operating outside the region. These codes must be used by all mobile and fixed land stations within North America, the eastern Pacific, and the Caribbean. These data groups are not encoded by the MRS, but must be manually entered. The 101-codes are used following the "51515" Regional Data Identifier group, as appropriate, in sections B and D of the TEMP codes.

Designated Synoptic stations use many of these 101 codes to indicate why a report for a scheduled sounding is not available at the normal time. Most Navy and Marine Corps upper-air observers use the code groups to explain the reason for sounding termination, to indicate levels of doubtful data, and to report corrected data. The FMH-3 contains a complete list of all 101 code groups. We will discuss where and how these codes groups are used within the TEMP code later in this chapter. In addition to the 101 codes, most ships insert the balloon release height immediately after the

Table 1-6.—Region IV Additional Data Groups

<b>REASON FOR NO REPORT OR AN INCOMPLETE REPORT</b>	<b>CORRECTED DATA FOLLOWS</b>
10140 Report not filed	10178 Tropopause data
10141 Incomplete report; full report to follow	10179 Maximum wind
10142 Ground equipment failure	10180 Entire report (parts to follow A, B, C, and D)
10143 Observation delayed	10181 Parts A and B
10144 Power failure	10182 Parts C and D
10145 Unfavorable weather conditions	10183 Parts A and C
10146 Low maximum altitude (less than 1500 feet AGL)	10184 Parts B and D
10147 Leaking balloon	10185 Minor error in this report. correction follows
10149 Military operations preclude sounding	10186 Additional significant levels not in original report follow
10150 Ascent did not reach 400 hPa level	10187 Surface data
10151 Balloon forced down by icing	10188 Additional data
10152 Balloon forced down by precipitation	
10153 Atmospheric radio interference	<b>DOUBTFUL DATA FOLLOWED BY ONE OR MORE OP<sub>n</sub>P<sub>n</sub>P<sub>n</sub>P<sub>n</sub> GROUPS, FOR LOWER AND UPPER LIMITS OF DATA</b>
10154 Local radio interference	
10155 Fading signal	10165 Altitude and temperature doubtful
10156 Weak signal	10166 Altitude doubtful
10158 Flight equipment failure (radiosonde, balloon, etc.)	10167 Temperature doubtful
10159 Any reason not listed above	10168 Dew-point depression doubtful

last 101 code group. This allows other units to enter the sounding into their TESS system and recreate an accurate sounding profile.

### REVIEW QUESTIONS

- Q24. *What causes an upper-air sounding to be automatically terminated by the MRS system?*
- Q25. *What program in the MRS produces a printout of the significant levels?*
- Q26. *What does the letter "U" indicate next to a significant level on the printout sheet?*
- Q27. *What is the purpose of selecting significant levels?*
- Q28. *What is the criteria for selecting a significant level wind based on direction?*
- Q29. *Which activities in WMO Region IV do NOT report fixed regional level winds?*
- Q30. *What do the "RI" and "MRI" columns indicate on the significant level printout sheet?*
- Q31. *What is the purpose of the 101 indicator groups?*

### PILOT BALLOON (PIBAL) WIND OBSERVATIONS

---

**LEARNING OBJECTIVES:** Identify the procedures and equipment used to conduct PIBAL observations. Identify the computer software routinely used to evaluate PIBAL observation data.

---

Pibal observations during the 1940's through the 1960's were the primary method used to determine atmospheric winds, and the balloons were tracked as high as possible. Today, the primary application for Pibal-observed winds is low-level wind measurements for tactical fixed and rotary-wing aircraft operations, and para-drop operations. Although most naval units have little need to conduct Pibal observations, U.S. Marine Corps observers attached to Mobile Weather Support Teams and Recon Units routinely conduct mobile-land station Pibal observations during field operations and exercises. The collected information is normally distributed locally in plain language, and rarely encoded for electronic distribution.

A *PIBAL* is a balloon that is inflated with helium or hydrogen to provide a fixed free lift, which, in turn,

produces a predictable ascension rate. It is tracked visually with an optical theodolite (an instrument used for measuring horizontal and vertical angles), with the observed azimuth and elevation angles recorded each minute. The height (AGL) of the balloon at each successive minute is based on a standard ascension rate for the size of the balloon. These ascension rates are listed in the FMH-3. When inflated properly to achieve a set free-lift weight, balloons are assumed to ascend at the standard rate, and true wind speed and direction are computed from the change in the horizontal position of the balloon.

### PIBAL OBSERVATION PROCEDURES

The equipment and procedures required to conduct a Pibal observation are thoroughly described in the Federal Meteorological Handbook Number 3. Guidance on encoding Pibal-observed winds by land, ship, or mobile observers in International code (FM32-IX PILOT, FM33-IX PILOT SHIP, AND FM34-IX PILOT MOBIL codes) with the required Regional and National coding practices are contained in the FMH-3. Additionally, the basic International code is covered in WMO Publication 306, Manual on Codes, Volume 1, *International Codes*.

### PIBAL EQUIPMENT

The equipment used to conduct a Pibal observation is fairly limited. You will need an ML-474 shore telescopic theodolite with an ML-1309 tripod (fig. 1-7) 30- or 100-gram balloons, a Universal Balloon Balance (PIBAL) weight set or the MK-216/GM balloon inflation nozzle and weight set, and a pressure-reducing helium regulator with hose. To evaluate the data, you will need either an appropriate calculator or computer and Pibal evaluation program, or you may use the manual method. The manual evaluation method requires the use of the MF5-20 Winds Aloft Computation Sheet, a set of "Balloon Distance Projected on a Curved Earth" scales (Horizontal Distance Out "HDO" scales) or a Horizontal Distance Computer (FCW-19) or an 18-C-58 PIBAL-RAWM calculator. An Aerological Plotting Board or Winds Aloft Plotting Board with the appropriate wind speed scale for the board, and a Winds Aloft Graphing Board or Wind Aloft Plotting Chart could also be used. The manual method is rarely attempted due to time requirements and the quantity and weight of the equipment. It has been replaced by the use of PIBAL software for hand-held programmable calculators and

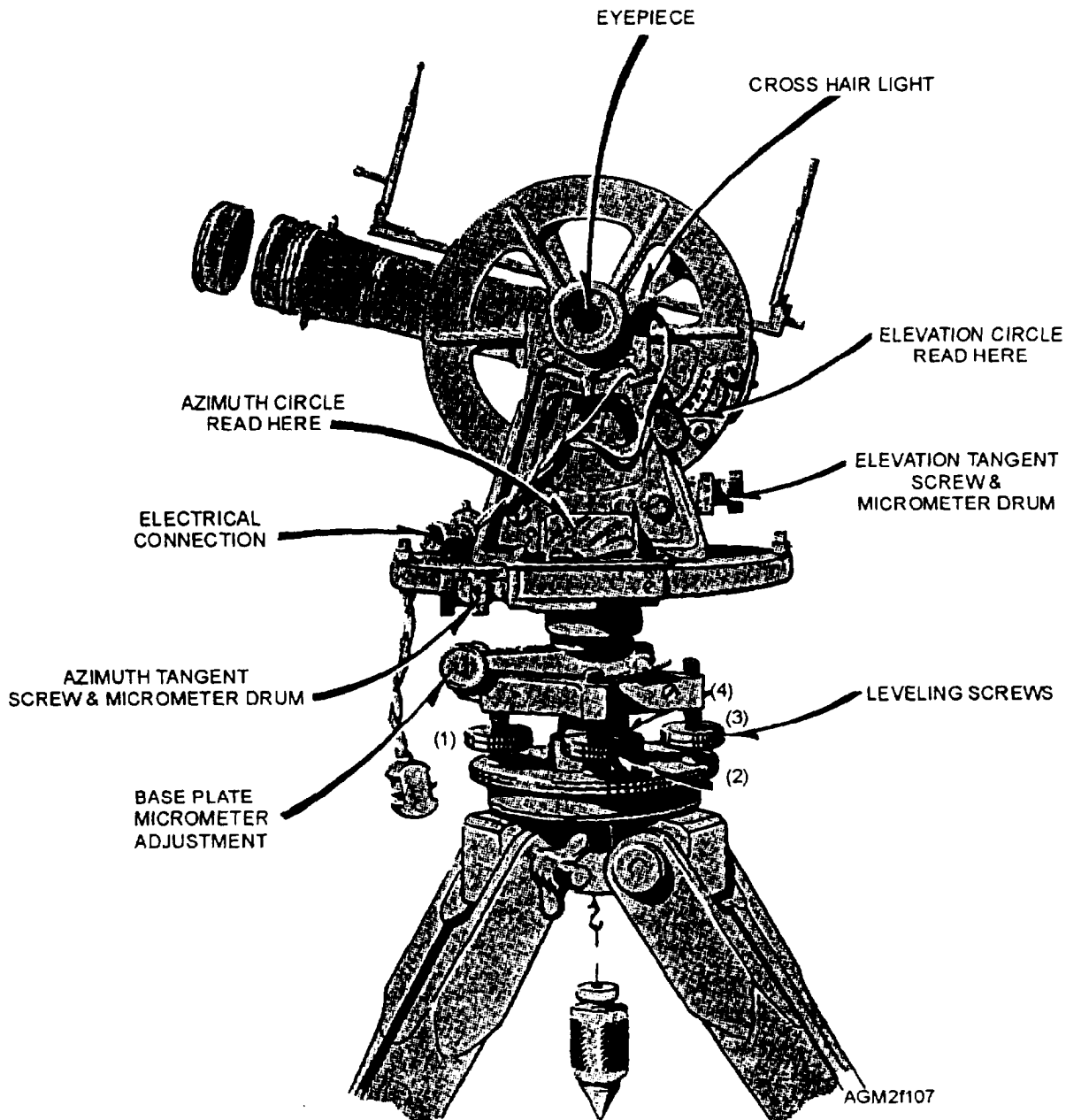

Figure 1-7.—ML-474 shore telescopic theodolite with an ML-1309 tripod.

desk-top computers available through the Geophysics Fleet Mission Program Library (GF MPL).

### Theodolite

The theodolite is used to obtain the azimuth and elevation angles of the balloon. These angles are read to the nearest one-tenth of a degree. For use at night, a battery-powered lighting circuit illuminates both the azimuth and elevation scale. The theodolite telescope has an adjustable focus and must be refocused several

times during the course of an observation. It also has a low-power setting for use early in the sounding, and a high-power setting for use when the balloon attains higher altitudes. The theodolite must be mounted on the tripod, leveled, and oriented to true north before use. Detailed guidance on the proper use, care, and storage of the theodolite is contained in the FMH-3 and AN 50-30WH-1, *Handbook of Overhaul Instructions with Parts Catalog for Theodolite AERO-1928-USN and Tripod AERO-1930-USN, and Signal Corps Theodolite ML-474 and Tripod ML-1309.*

### CAUTION

The observer's eyes will be permanently damaged by looking directly at the focused sun image through the theodolite. Therefore, the observer must use extreme caution following the balloon while it is near the sun's angular bearing, and never track the balloon across the sun's disk.

### Balloons

All pilot balloons are made of neoprene and are usually inflated with helium. A 100-gram balloon is used for a daytime scheduled Pibal that is expected to ascend 15,000 feet or more above the surface or during high-wind conditions. The 30-gram balloons are used for all other Pibals, including nighttime observations when equipped with a chemical light. The choice of color is to some extent a matter for the individual to decide. In general, white balloons are used with a clear sky; black balloons, with low or middle overcast, and red balloons, with high overcast. Usually, when haze, dust, or smoke is present in a cloudless sky, a white balloon remains visible longest. This is true because the sun shining upon it above a lower layer of haze creates scintillation—a twinkling or shimmering, which is absent when colored balloons are used.

Pilot balloons are inflated to achieve standard ascension rates. The 30-gram balloons are inflated with helium to neutral buoyancy while connected to the inflation nozzle weighted to exactly 139 grams (192 night). The 100-gram balloons are inflated with helium to neutral buoyancy while connected to the inflation nozzle weighted to exactly 515 grams (552 night). The length of cord used to tie the balloon neck is draped over the nozzle during inflation of the balloon. For nighttime observations, the additional weight of a chemical light is compensated for by hanging an unactivated light on the nozzle during inflation.

The initial ascension rate (216 ft/min for 30-gram and 350 ft/min for 100-gram balloons) slows gradually as the balloon expands. The height of either size balloon at any time is listed in the FMH-3, and is also printed on the MF5-20 Winds Aloft Computation Sheet. The computer evaluation programs calculate balloon height based on the time in flight. A surface wind observation must be taken no more than 5 minutes before release.

### Lighting Units

Tracking a night Pibal is made possible by attaching a lightweight chemical light to the balloon. The lighting unit should be activated just prior to the release in accordance with the manufacturer's instructions. You may use any color high-intensity chemical light, although green is most often used.

### WIND EVALUATION

The GFMPL programs that evaluate Pibal winds only require the size of the balloon used and the consecutive minute readings of azimuth and elevation to determine wind speed and direction by the minute and/or in 1,000-foot (AGL) increments.

If the data is to be encoded for transmission, only standard pressure level and fixed level (or significant level winds) are reported. Pibal observations that do not extend to at least 1,000 feet are not transmitted. Guidance for the determination and selection of levels is contained in Appendix D and E of the FMH-3. These wind levels are determined after the consecutive minute or 1,000 foot winds are plotted on the Winds Aloft Graphing Board or the Winds Aloft Plotting Chart. Normally, 5 consecutive minutes of missing data will necessitate a new launch in addition to any equipment problems, such as a loose base clamp, etc. Missing data for less than 5 minutes may be interpolated. If severe or unusual weather exists in the vicinity of the observation site, a second verifying Pibal should be taken as soon as possible. After the observed data is plotted and evaluated, it is encoded in the PILOT code, as discussed later in this chapter.

Earlier in this chapter, we introduced the different codes used to relay upper-air observation data. We have briefly discussed the Mini Rawinsonde System observation procedures and indicated that the MRS automatically encodes the observed data in the appropriate form of the TEMP code. We have also mentioned that if Pibal-observed winds are encoded for relay, the PILOT code form is used. Although not every Navy or Marine Corps observer will have the opportunity to conduct upper-air observations, all will routinely use data contained in coded upper-air observation reports.

### REVIEW QUESTIONS

- Q32. What is the primary purpose of Pibal observations?*
- Q33. What instrument is used to track pilot balloons?*

- Q34. During a Pibal observation, how are true wind direction and speed computed?
- Q35. Which publication contains detailed information on conducting Pibal observations?
- Q36. What software package contains a program for automatic computation of Pibal observation data?
- Q37. What color Pibal balloon is normally used when the sky is clear?

### UPPER-AIR REPORTING CODES

**LEARNING OBJECTIVES:** Recognize the applications for upper-air observation reporting codes. Identify the observation location and time in an upper-air report. Identify the standard upper-air observation times.

Upper-air codes are designed to allow transmission of a large amount of data using only a small number of characters. The numerically coded data allows the report to be decoded by a weather person in any country, regardless of the language spoken. More importantly, this numerically coded format can be readily transmitted by computer. These codes may be easily loaded into computer programs that analyze the upper-air data, plot graphical displays, and then calculate probable changes in the reported conditions. The resulting information serves as an invaluable forecast aid.

Reports of conditions measured during any of the various upper-air observations are normally encoded in WMO international codes for dissemination. International upper-air observation reporting codes were established by the WMO to allow all countries of the world to exchange data. Because there are many different types of upper-air observations conducted each day, several similar codes are in use to efficiently report the data collected. Table 1-7 shows the different types of upper-air observations conducted, the types of data observed and reported, and the WMO International code form used to format the report.

Reports received in these codes are routinely used by weather personnel for routine aviation support, weather-forecasting support, and as input for TESS. Additionally, these observations provide primary input to the Navy's environmental prediction system at the

Fleet Numerical Meteorology and Oceanography Center, and to the National Weather Service's environmental prediction system at the National Meteorological Center. Navy and Marine Corps observers must be able to decode all upper air observation codes. And, as stated earlier, they must be able to encode, or verify, the MRS computer encoding of the various forms of the TEMP code.

### IDENTIFYING MESSAGE CODE FORM

Nearly all coded upper-air-report messages contain a four-letter code identifier as the first group of the first line of data. All upper-air codes except the AMDAR code have a common format for the data identification line. As encoded for transmission, identification data appears in the first line of the message. The symbolic format for the identification data groups is as follows:

$M_i M_j M_k M_l$  YGGI<sub>a</sub> Iiii (land stations)

o r

$M_i M_j M_k M_l$  D . . . D 99L<sub>a</sub>L<sub>a</sub>L<sub>a</sub> Q<sub>c</sub>L<sub>o</sub>L<sub>o</sub>L<sub>o</sub>L<sub>o</sub>

MMM<sub>U</sub><sub>L<sub>a</sub></sub>U<sub>L<sub>o</sub></sub> (h<sub>o</sub>h<sub>o</sub>h<sub>o</sub>h<sub>o</sub>i<sub>m</sub>)

(ship/aircraft/mobile land stations)

The first group,  $M_i M_j M_k M_l$ , is found in nearly every international coded report, and is the code identifier. The  $M_i M_j$  identifies the code type. See the second column of table 1-7. The  $M_k M_l$  identifies which part of the multi-part upper-air reports is contained in the section of the report: AA for Part A, BB for Part B, and so forth. If all of the observed data is routinely distributed as a single message, such as the CODAR report, the  $M_k M_l$  is encoded XX. The first group of the coded report also contains the observation time and the location of the sounding.

### IDENTIFYING OBSERVATION TIME AND LOCATION

The WMO has established standard times for conducting upper-air observations: they are the synoptic hours of 0000Z, 0600Z, 1200Z, and 1800Z. Most balloon releases actually take place 30 to 45 minutes before these times so that the scheduled observation time actually occurs near the middle of the observation.

Because of time, personnel, and budget considerations, most stations do not conduct observations at each of the synoptic hours. If only two upper-air soundings are taken per day, they are taken at 0000Z and 1200Z. If only one upper-air sounding is conducted, it is taken at 0000Z or 1200Z, whichever time is closest to local sunrise.



Table 1-7.—Upper-Air Observation Types and Reporting Codes

WMO CODE	ID	OBSERVATION SITE	DATA	OB TYPE
FM 32-IX-PILOT	PP—	Fixed Land Site	Upper	PIBALs
FM 34-IX-PILOT MOBIL	EE—	Mobil Land Site	Wind	
FM 33-IX-PILOT-SHIP	QQ—	Ship	Reports	
FM 35-X-TEMP	TT—	Fixed Land Site	Upper level	RAWIN-, RADIO-, DROP-, SONDEs, and RABALs
FM 38-X-TEMP MOBIL	II—	Mobil Land Site	Pressure	
FM 36-X-TEMP SHIP	UU—	Ship	Temperature	
FM 37-X-TEMP DROP	XX—	Aircraft	Humidity Winds	
FM 39-VI-ROCOB	RRXX	Fixed Land Site	Upper level	ROCKETSONDEs
FM 40-VI-ROCOB SHIP	SSXX	Ship	Air density Temperature Winds	
FM 41-IV-CODAR	LLXX	Aircraft	Upper level Pressure Temperature Winds	Aircraft (manual)
FM 42-XI AMDAR	none	Aircraft	Upper level Pressure Temperature Dew point Winds	Aircraft to satellite data relay

**NOTE:** "—" indicates multi-part messages (AA, BB, CC, or DD).

The observation time is coded in the third group of the first line of data in the form **YYGGI<sub>d</sub>**. This is the date/time group, with *YY* indicating the day of the month, and *GG* indicating the synoptic hour of the observation. The *I<sub>d</sub>* is an indicator that is different in each code and will be discussed later.

On most reports received via telecommunications circuits, computers have already “read” the code identifier and date/time group and printed a message header at the top of the bulletin. A single bulletin may contain several Part A, TEMP SHIP, reports from different ships, all under a header such as UUA 211200Z NOV.

The location where the observation was conducted is identified differently in the various code forms. Ship observations and mobile land-observation sites are

located by latitude, longitude, and Marsden Square coordinates, which pinpoint the location. Established land stations are located only by referencing the international block and station number (Iiii) on weather plotting charts or in the *Master Weather Station Catalog*.

The identification groups "D. . . .D **99L<sub>a</sub>L<sub>a</sub>L<sub>a</sub> Q<sub>c</sub>L<sub>o</sub>L<sub>o</sub>L<sub>o</sub>L<sub>o</sub> MMMU<sub>L<sub>a</sub></sub>U<sub>L<sub>o</sub></sub>**" are used only by movable observation platforms to identify the observation platform and the location of the observation. All ships, mobile observation sites ashore, and aircraft use these groups. As in the Ship Synoptic code FM 13-X SHIP, discussed in module 1, the "D. . . .D" is the call sign of a ship or the call sign or communications identifier assigned to a mobile unit. The "**99L<sub>a</sub>L<sub>a</sub>L<sub>a</sub> Q<sub>c</sub>L<sub>o</sub>L<sub>o</sub>L<sub>o</sub>L<sub>o</sub>**" groups are the latitude

and longitude of the observation, exactly as used in the ship synoptic reports. The **MMMU<sub>La</sub>U<sub>Lo</sub>** group is a second location reporting group, which contains the Marsden Square number of the location, **MMM** (see Appendix II) and Marsden sub-grid locations **U<sub>La</sub>** (a repeat of the units digit of the latitude) and **U<sub>Lo</sub>** (a repeat of the units digit of the longitude). Some computers use only the Marsden group to enter the position of the upper-air report in the analysis program. The latitude and longitude groups are used by people to determine the exact location. Both groups must be correct.

In place of the latitude, longitude, and Marsden Square groups, permanent shore stations report only one group: **IIiii**. This is the WMO block (11) and station number (iii) exactly as used, and described in module 1, for the Land Synoptic code. Mobile land stations include an additional group (**h<sub>0</sub>h<sub>0</sub>h<sub>0</sub>i<sub>m</sub>**) that reports the station elevation in either meters or feet.

The breakdown of all the different upper-air reporting codes and code formats is contained in the WMO Publication 306, Manual on Codes, Volume 1, *International Codes*. The majority of these coded messages are "read" automatically by computers and entered into analysis programs for use. In selected situations where manual decoding is required, the observer should consult WMO Publication 306. Both the TEMP code and the PILOT code forms are routinely used by observers to encode observed data. We will discuss these codes in the following text.

## TEMP CODE

---

**LEARNING OBJECTIVES:** Identify the differences and similarities in the four forms of the TEMP code. Describe the information contained in each part of the TEMP coded report. Explain the format and the meaning of each coded part of the TEMP report. Describe the modifications added to the International code form in WMO Region IV. Describe the format and contents of an Early Transmission Message.

---

Although used by computers, the TEMP coded upper-air information is also used extensively in many manual applications. For detailed analysis, TEMP coded data is decoded and plotted on a Skew-T, Log P Diagram, or on horizontal or time section diagrams. The TEMP code is the primary upper-air reporting

code. Every observer must be thoroughly familiar with this code.

The different forms of the TEMP codes are used to report data gathered in the rawinsonde, radiosonde, or rabal observations, depending on the site used to launch the balloon. However, aircraft-launched dropsondes use a slightly different code format. The four different forms of the TEMP code are listed in table 1-7.

## COMPOSITION OF THE REPORTS (MESSAGE)

All four forms of the TEMP code are broken down into four parts to speed distribution. Additionally, each code part is divided into data sections. The data sections contain information in five-digit groups, although letters are used in one or two groups in the identification data section. Each figure in each group is significant to its position in the group and to its position in the message. Therefore, the established order of the groups in the messages must be maintained. When observed data is not available for an element, a slant (/) is used instead. This is done to preserve continuity of the groups and sections as required.

### Message Parts

Each TEMP code part may be transmitted as an independent message. This is done to speed distribution of the reports, because a sounding usually takes a considerable amount of time. A radiosonde may continue to report usable data 2 to 3 hours after release. The parts are identified as A, B, C, and D. Data at and below the 100-hPa level is reported in Parts A and B, and data above 100 hPa is reported in Parts C and D.

Parts A and C contain data pertinent to the **standard atmospheric pressure surfaces**, which are also called the mandatory reporting levels. Parts B and D contain data pertinent to the significant levels. These are the levels that have been determined significant due to temperature and/or humidity change, and changes in wind speed or direction. The following diagram may help clarify what data is included in each section:

PART A Mandatory Levels SFC to 100 hPa	PART C Mandatory Levels 100 hPa and higher
PART B Significant Levels SFC to 100 hPa	PART D Significant Levels 100 hPa and higher

All military stations designated to encode and transmit upper-air observations encode and transmit the

Early Transmission Message, and Parts A, B, C, and D. Each part of a code may be sent as a separate message as soon as the data is evaluated and encoded. The Early Transmission Message is manually composed while the first data levels are being received. Part A is available from the computer first, even while the observation of the higher levels is still being measured. Part B is available a short time later. Parts C and D are not available until after the upper-air sounding has been terminated. Many stations send each part as a separate message. Because of this, upper-air reports may be received in parts at different times after the synoptic hour.

With rapid electronic equipment, the number of messages, rather than message length, is often the key factor in speed of transmission. The MRS processor, when connected to a desktop computer or the TESS, rather than a printer, allows for formatted and completely composed messages to be delivered transmission-ready to the communications center. Whether all parts are included in a single message will depend upon a number of factors that change from day to day. When broken into separate sections, the Early Transmission Message has first transmission priority; Parts A and C have second priority; and Parts B and D have third priority.

### Identification Data Section

Each part of TEMP code contains data for up to 10 code sections. These sections are not readily apparent in the coded message, and except for Section 1, Identification Data, the type of data that each section contains varies from part to part.

The identification data for each part of the code is nearly identical, and it is contained in the first line of each message part. We have already discussed the format of the identification data used with upper-air codes, and the "data type" identifiers for the different TEMP codes. Data type TTAA indicates a TEMP code report from a fixed land station (message Part A), while UUDD indicates a TEMP SHIP coded report from a ship (message Part D), and so forth.

The only difference in the identification data for the TEMP and the other upper-air codes is the indicator in the YYGGI<sub>d</sub> group, and the method used to encode the UTC date for YY. The TEMP code uses indicator I<sub>d</sub> in message Parts A and C, but contains indicator a<sub>4</sub> in Part B. In Part D, the indicator is replaced by a "/." The I<sub>d</sub> is the indicator for the highest mandatory pressure level for which winds are reported (WMO code table 1734). If, for example, winds are reported to the 50-hPa level,

the indicator as used in Part A would be "1," because Part A would include winds to the 100-hPa level; and the indicator in Part C would be "5," because the winds in Part C would be reported to the 50-hPa level. The a<sub>4</sub> in Part B is a code figure for the type of measuring equipment used (WMO code table 0265), which should be reported as a 0 for the MRS system. The coding of the date, YY, identifies the wind-speed reporting units. If the wind speeds are reported in knots, as are all U.S. Military observations, 50 is added to the UTC day of the month. The 22d day of the month would be encoded 72. When the winds are reported in the standard meters per second, YY is simply the day of the month.

With the exception of the identification data, the data contained in each message part is the same for the different "TEMP" code forms. A TEMP report, a TEMP MOBIL report; a TEMP SHIP report, and a TEMP DROP report will all encode the same data using identical data formats.

### REVIEW QUESTIONS

- Q38. *What is the purpose of the upper-air observation code?*
- Q39. *What activity would use the FM 38-X TEMP MOBIL code?*
- Q40. *What are the standard times for conducting routine upper-air observations?*
- Q41. *If only one daily upper-air observation is required, what standard time should be selected?*
- Q42. *How are ship locations identified?*
- Q43. *Parts "A" and "C" of a TEMP coded message contain what type of information?*
- Q44. *What is the purpose of an early transmission message?*
- Q45. *What type of information would be contained in an upper-air message with the header "UUAA"?*
- Q46. *In an upper-air message, when is 50 added to the date?*
- Q47. *What does the information "TTAA 59121" indicate?*

### PART A - LOWER MANDATORY LEVELS

Part A of the coded message contains identification data, pressure, temperature, dew-point depression,

winds, tropopause data, and maximum wind data. Table 1-8 shows the symbolic representation of the data in Part A, along with examples of coded data.

### Identification Data

In the Identification Data section (section 1), example (1) shows typical coded identification data for a fixed land station 1200Z observation on the 14th day of the month from block 72, station 306, with winds in knots. Example (2) shows similar data for a mobile land station: 1200Z observation on the 14th day of the month from site 35.2°N, 078.7° W, Marsden Square 116, with winds in knots, and a station height of 100 feet. Example (3) is from a ship, the "NSHP" with a 1200Z observation on the 14th day of the month at 31.1° N, 072.1° W, Marsden Square 116, with winds in knots. Example (4) is an aircraft dropsonde directly over

NSHP at the same time, except wind speeds are in meters per second.

### Mandatory Level Data

The Mandatory Level data in section 2 contains the bulk of the coded data in this part of the report. The format for the surface data is slightly different from the format for the remaining mandatory atmospheric levels reported in Part A. The mandatory levels reported in this part are the surface, 1,000 hPa, 925 hPa, 850 hPa, 700 hPa, 500 hPa, 400 hPa, 300 hPa, 250 hPa, 200 hPa, 150 hPa, and 100 hPa.

For the surface, the three five-digit data groups report surface pressure, temperature and dew-point depression, and winds. For each of the mandatory levels, the three five-digit groups report the pressure

**Table 1-8.—Part "A" TEMP Coded Upper-Air Report (Surface to 100-hPa Level Mandatory Reporting Levels)**

SEC	SYMBOLIC FORMAT	CONTENTS
1	<p><b>M<sub>i</sub>M<sub>i</sub>M<sub>j</sub>M<sub>j</sub> YYGGI<sub>d</sub> Iiii</b>            Example:            (1) TTAA 64121 72306</p> <p><b>M<sub>i</sub>M<sub>i</sub>M<sub>j</sub>M<sub>j</sub> D. . . .D YYGGI<sub>d</sub> 99L<sub>a</sub>L<sub>a</sub>L<sub>a</sub> Q<sub>c</sub>L<sub>o</sub>L<sub>o</sub>L<sub>o</sub>L<sub>o</sub></b>  <b>MMM<sub>U<sub>La</sub></sub>U<sub>Lo</sub></b> (h<sub>o</sub>h<sub>o</sub>h<sub>o</sub>h<sub>o</sub>i<sub>m</sub>)</p> <p>Examples:            (2) IIAA 64121 99352 70787 11658 01002            (3) UUA A NSHP 64121 99311 70721 11612            (4) XXAA 14121 99311 70721 11612</p>	<p>Identification Data             (Land station)</p> <p>Identification Date             (Mobile-land station)            (Ship)            (Aircraft)</p>
2	<p><b>99P<sub>0</sub>P<sub>0</sub>P<sub>0</sub>T<sub>0</sub>T<sub>0</sub>T<sub>a0</sub>D<sub>0</sub>D<sub>0</sub> d<sub>0</sub>d<sub>0</sub>f<sub>0</sub>f<sub>0</sub>f<sub>0</sub></b> (surface)  <b>P<sub>n</sub>P<sub>n</sub>h<sub>n</sub>h<sub>n</sub>h<sub>n</sub> T<sub>n</sub>T<sub>n</sub>T<sub>an</sub>D<sub>n</sub>D<sub>n</sub>d<sub>n</sub>f<sub>n</sub>f<sub>n</sub>f<sub>n</sub></b> (all other levels)            Example:  <b>99030 05050 09015 00211 06060 09005 92353 02227 08021</b>  <b>85490 00646 07016 70010 06900 08527 50560 22764 09047</b>  <b>40718 33372 09045 30916 459// 09071 25090 543// 09096</b>  <b>20225 581// 09099 15475 595// 09615 10745 575// 09100</b></p>	Mandatory Pressure Level data
3	<p><b>88P<sub>t</sub>P<sub>t</sub>P<sub>t</sub>T<sub>t</sub>T<sub>t</sub>T<sub>at</sub>D<sub>t</sub>D<sub>t</sub> d<sub>t</sub>d<sub>t</sub>f<sub>t</sub>f<sub>t</sub>f<sub>t</sub></b> or 88999            Example:  <b>88225 589// 09098</b></p>	Tropopause data
4	<p><b>77P<sub>m</sub>P<sub>m</sub>P<sub>m</sub>d<sub>m</sub>d<sub>m</sub>f<sub>m</sub>f<sub>m</sub>f<sub>m</sub> (4v<sub>b</sub>v<sub>b</sub>v<sub>a</sub>v<sub>a</sub>)</b> or 77999            Example:  <b>77132 09628 40508</b></p>	Max wind and wind-shear value

level and the altitude of the level, temperature and dew-point depression, and winds. The three groups are repeated for each of the mandatory levels.

**NOTE:** In table 1-8. the subscripts used with each of the symbolic letters are the international symbolic format. The subscripts identify the level for which the data is being reported. such as the subscript "0" for surface, "1" for first level, "n" for any other level, "t" for tropopause level, and "m" for max-wind level. Although these subscripts are necessary when "looking up" the appropriate definition for a symbolic code letter in the International Codes manual, the subscripts make the code seem more complicated than it really is. We will ignore the subscripts used to identify the level in the remainder of this discussion on the TEMP code. Only significant subscripts used to define terms for other purposes are included.

**SURFACE PRESSURE.**—In the first of the three groups for surface information. the 99 is the indicator for "surface information" while the **PPP** is the hundreds, tens. and units of the surface pressure in hectopascals. In the example. 030 represents 1,030 hPa.

**PRESSURE LEVEL ALTITUDE.**—The first of the three groups for the remaining "mandatory levels" contains **PP**. the hundreds and tens digits of the reported pressure level, and **hhh**, the altitude in meters or decameters of the reported pressure level. For levels up to and including 700 hPa, the altitude is reported in three digits to the nearest meter with the thousands value, if any, deleted. For all levels above 700 hPa, the altitude is reported to the nearest decameter (tens of meters) with the ten-thousands value deleted. Refer to table 1-6 in module I, (Standard Pressure Surfaces) to determine the standard altitudes of the mandatory levels from the 1,000- to 10-hPa levels. For example. an 850-hPa level altitude of 1,457 meters is encoded 85457. To decode a reported altitude in Part A of 10711, the first two digits. 10, indicate the 100-hPa level. The 711 is the altitude in decameters, or "something-7,110 meters." Since the standard altitude of the 100-hPa level is approximately 16,180 meters (with the ten-thousands value of 1), one could correctly assume that the reported altitude is actually 17,110 meters.

**TEMPERATURE / DEW - POINT DEPRESSION.** —Following the surface-pressure group and the pressure-level/altitude groups, the next group contains the coded temperature and dew-point depression. The temperature is reported by **TTT<sub>a</sub>**. The **TT** is the tens and units value of the temperature, in degrees Celsius. at the surface or the pressure level. The tenths value of the temperature is also used to indicate

whether the reported temperature is positive or negative in the coded **T<sub>a</sub>**. Zero, and all even "tenths values" in this position indicate a positive temperature. while an odd value indicates a negative temperature. When encoding, the tenths value is dropped to the next lower tenths value, if necessary, to indicate the proper temperature sign. For example, a temperature of -23.8°C is encoded 237, while a temperature of +23.9°C is encoded 238.

The radiosonde instrument measures temperature and relative humidity, and the MRS system (or observer) calculates the difference between the two instrument-reported readings when determining dew-point temperature. Only the *dew-point depression*, or the absolute difference between the air temperature and the dew-point temperature (with respect to liquid water), is reported in the TEMP code by **DD**, a coded figure. Dew-point depression (always an unsigned number), is normally calculated to the nearest tenth of a degree Celsius, and encoded using WMO code table 0777. Code figures 00 through 50 report dew-point depressions from 0.1°C through 5.0°C, respectively. Code figures 56 through 99 represent dew-point depressions rounded off to the nearest whole degree from 06°C through 49°C (subtracting 50 from the coded figure yields the dew-point depression in whole degrees).

**WINDS.**—The group **ddfff** is used to report wind direction and wind speed. The **dd** is the true direction in tens of degrees from which the wind is blowing. Observed wind directions are rounded off and reported to the nearest 5 degrees, as specified by WMO regulations. The **fff** is the wind speed in hundreds, tens, and units. The units of speed are specified in the Identification Data section. For example, a wind from 275° true at 159 knots is encoded 27659; winds of 275° at 25 knots are encoded 27525, and winds of 270° at 25 knots are encoded 27025.

### Tropopause Data

In table 1-8, tropopause data is contained in section 3 of message Part A, and may also be contained in Part C in the identical format. Tropopause data is only reported in the part of the message (A or C) that pertains to the level of the atmosphere in which the tropopause is located. The *tropopause level* is selected by the MRS system as the base of the layer in which the temperature stops decreasing with height or decreases very slowly with height, normally between the 250 hPa and 200 hPa level. Criteria on which the MRS system makes the selection is contained in the Federal Meteorological

Handbook Number 3. In some cases, there may be more than one tropopause, one below the 100-hPa level and the other above the 100-hPa level. In this case, both Parts A and C may report tropopause data.

Following the mandatory level data, three groups, **88PPP**, **TTT<sub>a</sub>DD**, and **ddfff**, contain information very similar to the mandatory level information that pertains to the tropopause level. If the sounding did not locate a tropopause, the group 88999 is used in place of the data groups.

**INDICATOR AND PRESSURE LEVEL.**—The 88 is the indicator that tropopause data follows. The **PPP** is the pressure level, to the nearest hectopascal, at which the tropopause is located.

**TEMPERATURE AND DEW-POINT DEPRESSION.**—The **TTT<sub>a</sub>DD** is the temperature and dew-point depression, encoded in the same manner as the mandatory level data.

**WINDS.**—The wind direction and speed, **ddfff**, are encoded in the same manner as the mandatory levels.

### Maximum Wind

In table 1-8, section 4 contains information on maximum winds. Information on the highest winds observed between the 500-hPa level and the 100-hPa level, in excess of 60 knots, is contained in the Maximum Wind data group. Maximum winds located above the 100-hPa level are reported in an identical section in message Part C. Maximum wind data is reported in two or three groups. In the first group, 77 is the indicator for maximum wind, followed by **PPP**, the pressure level of the maximum wind to the nearest hectopascal. The second group, **ddfff**, contains the wind direction and speed, as precisely described. The third group, **4v<sub>b</sub>v<sub>b</sub>v<sub>a</sub>v<sub>a</sub>**, is optional, and is used to report the absolute value of the vertical wind shear. The **v<sub>b</sub>v<sub>b</sub>** reports the vertical wind shear difference between the level of maximum wind and the winds 3,000 feet below the level of maximum wind, while the **v<sub>a</sub>v<sub>a</sub>** reports the vector difference between the level of maximum winds and the winds 3,000 feet above the level of maximum wind. The vertical wind shear values are important indicators for clear air turbulence (CAT). The procedure to calculate vertical wind shear is discussed in the FMH-3.

When no winds in excess of 60 knots are observed between the 500-hPa level and the 100-hPa level, the group 77999 is reported. If two winds with identical

wind speeds satisfy the criteria for a maximum wind, the levels will be encoded successively, beginning with the lowest altitude.

## REVIEW QUESTIONS

- Q48. How would the position of a ship located at 27.0N 152.0W be encoded?
- Q49. What information is contained in Part A of the TEMP code?
- Q50. Given the following: "85397 02659 24035." What is the altitude of this level?
- Q51. When is 50 added to the dew-point depression?
- Q52. How are mandatory pressure level winds reported?
- Q53. How should the following information "70910 09163 33514" in Part A of a TEMP message be decoded?
- Q54. What is the indicator for tropopause data in Part A?
- Q55. How should the following information "77220 07602 40508" in Part A of a TEMP message be decoded?

## PART B - LOWER SIGNIFICANT LEVELS

The second part, Part B of the TEMP coded messages (see table 1-9), contains data on levels that are considered significant because of changes noted in the temperature, humidity, or wind data. Although the significant levels are selected by the MRS, you must verify the selection of significant levels. When the MRS processor selects levels, it first considers the mandatory significant level criteria, followed by the "supplemental" significant level criteria. Then, the MRS automatically encodes Part B. Remember however, some stations do not report significant wind levels.

### Selection of Significant Levels

Proper evaluation of an upper-air sounding requires that the operator select significant levels when a sounding is conducted using manual equipment. The Mini Rawinsonde System automatically searches for and encodes significant levels. MRS operators must review and verify the computer-selected levels. In general, significant levels are selected with respect to temperature, humidity, and wind changes.

## Symbolic Form of Part B

Part B (Table 1-9) consists of several sections of data. It starts with an Identification Data section (section 1), followed by section 5, data for each significant level selected with respect to temperature or humidity changes; section 6, data for significant levels selected with respect to changes in the wind direction or speed; section 7, sounding system data and observation time; section 8, observed cloud data; and ends with sections 9 and 10, regional and nationally coded data groups. Ship observations also report the sea surface temperature data in section 7.

### Significant Temperature/Humidity Levels

Section 5 (Table 1-9) contains data for each level selected as significant for either temperature or humidity. Data for each significant level is contained in two five-digit groups, **nnPPP** and **TTTDD**, which are repeated for each significant level selected. The first group contains a level identifier, **nn**, and the pressure, **PPP**, of the level in hundreds, tens, and units of hectopascals. The level identifier is a two-digit number. The surface (and only the surface) is always 00. All

remaining significant levels are identified, from lower to higher, as 11, 22, 33, . . . , 99, 11, 22, and so forth. If a level previously reported in Part A also fits the criteria for a significant level, it is reported again in this section as a significant level. The second group, **TTTDD**, is the temperature and dew-point depression, exactly as reported for the mandatory levels. Winds are not reported for these levels.

If temperature or humidity is missing, the top and bottom boundaries of the missing data layer are significant levels. At least one additional level must be selected within the layer of missing data. to indicate the missing data. The missing data is encoded with slants. For example, "55745 01522 66680 061// 77650 08310" identifies three significant levels. The base of a missing humidity layer, level 55, is at 745 hPa, with a temperature - 1.5°C and dew-point depression of 2.2°C. The top of the layer, level 77, is at 650 hPa, with a temperature of -8.3°C and dew-point depression of 1.0°C. The fact that the humidity data is missing in this layer is revealed by significant level 66 at 680 hPa, with a temperature of -6.1°C and "/" encoded in place of the dew-point depression.

Table 1-9.—Part "B" TEMP Coded Upper-Air Report (Surface to 100-hPa Level Significant Reporting Levels)

SEC	SYMBOLIC FORMAT	CONTENTS
1	<b>M<sub>i</sub>M<sub>r</sub>M<sub>j</sub>M<sub>j</sub> YYGGa<sub>4</sub> IIIii</b> o r Example: (1) TTBB 64120 72306 <b>M<sub>i</sub>M<sub>r</sub>M<sub>j</sub>M<sub>j</sub> D...D YYGGa<sub>4</sub> 99L<sub>a</sub>L<sub>a</sub>L<sub>a</sub> QcL<sub>o</sub>L<sub>o</sub>L<sub>o</sub>L<sub>o</sub> MMMU<sub>La</sub>U<sub>Lo</sub></b> (h <sub>o</sub> h <sub>o</sub> h <sub>o</sub> h <sub>o</sub> i <sub>m</sub> ) Examples: (2) IIBB 64120 99352 70787 11658 01002 (3) UUBB NSHP 64120 99311 70721 11612 (4) XXBB 14123 99311 70721 11612	Identification Data (Land station)  Identification Data (Mobile-land station) (Ship) (Aircraft)
5	<b>n<sub>n</sub>n<sub>n</sub>P<sub>n</sub>P<sub>n</sub>P<sub>n</sub>T<sub>n</sub>T<sub>n</sub>T<sub>n</sub>T<sub>n</sub>D<sub>n</sub>D<sub>n</sub></b> Example: 00030 05050 11930 06040 22847 004333770 02920 44650 10100 55600 1474066435 29769 77358 38170 etc.	Significant temperature and humidity levels
6	21212 <b>n<sub>n</sub>n<sub>n</sub>P<sub>n</sub>P<sub>n</sub>P<sub>n</sub>d<sub>n</sub>d<sub>n</sub>f<sub>n</sub>f<sub>n</sub></b> Example: 21212 00030 1301511990 17022 22985 17035 33972 17015 44925 18005 55860 19015 66700 2002577550 22040 88320 23050 99300 2307011260 23112 22220 23090 33101 24060	Significant wind levels
7	31313 <b>s<sub>r</sub>r<sub>a</sub>r<sub>a</sub>s<sub>a</sub>s<sub>a</sub> 8GGgg 9s<sub>n</sub>T<sub>w</sub>T<sub>w</sub>T<sub>w</sub></b> Example: 31313 46105 81135 90156	System status, time of launch, and Sea-water temperature
8	41414 <b>N<sub>n</sub>C<sub>L</sub>hC<sub>M</sub>C<sub>H</sub></b> Example: 41414 43322	Cloud data
9	code groups following indicator groups 51515, 52525, through 59595	Regional codes
10	code groups following indicator groups 61616, 62626, through 69696	National codes

## Significant Wind Levels

The beginning of section 6 may be identified in the coded message by the indicator group 21212. This section is used to report winds at "significant wind levels." All observers on U.S. Navy ships, Marine Corps, and naval upper-air observers operating outside WMO Region IV report significant level winds in this section, and need not report any information in the PILOT reporting code. Synoptic stations and other land or mobile land stations within WMO Region IV do not include this group in the TEMP coded report. Instead, the Fixed Regional Level Winds are reported using the appropriate PILOT code message Parts B and D.

Data for each significant wind level is contained in two groups of five-digit numbers, **nnPPP** and **ddfff**, which are repeated for each level selected. The first group for each level is used the same as in the significant temperature levels: it contains the level identifier **nn** and the pressure level **PPP**. The second group, **ddfff**, is the wind direction and speed. Encoding is the same as in part A of the code. Levels of missing wind data are reported similarly to missing significant levels of temperature and humidity.

## System Status and Seawater Temperature

Section 7 (Table 1-9), 31313 **s<sub>r</sub>r<sub>a</sub>r<sub>a</sub>s<sub>a</sub>s<sub>a</sub> 8GGgg 9s<sub>n</sub>T<sub>w</sub>T<sub>w</sub>T<sub>w</sub>**, contains information on the rawinsonde system used for the observation, the actual launch time of the instrument, and the seawater temperature. The 31313 is the section identifier.

In the second group, **s<sub>r</sub>r<sub>a</sub>r<sub>a</sub>s<sub>a</sub>s<sub>a</sub>**, the **s<sub>r</sub>** is the solar and IR radiation correction, found from WMO Code Table 3849. MRS systems use code figure 4, solar and IR radiation corrected automatically by system. The **r<sub>a</sub>r<sub>a</sub>** is the code for the rawinsonde system used and is obtained from WMO Code Table 3685. The current MRS system is reported by code 61 for the "Vaisala RS-80 Marwin." The **s<sub>a</sub>s<sub>a</sub>** is the tracking technique and system status, from WMO Code Table 3872. Code 05 is used with MRS equipment using VLF-Omega frequencies. GPS equipped systems will use code figure 08.

The actual UTC time of the radiosonde release is entered in the fourth group following the 8 indicator. If the radiosonde instrument is released at 1120Z, the group would read 81120.

The seawater temperature group is only reported by ships, and is deleted in reports from other stations. It is in the fourth group, which begins with the indicator 9.

The **s<sub>n</sub>**, the sign of the temperature (0 for positive and 1 for negative) is followed by the water temperature (**T<sub>w</sub>T<sub>w</sub>T<sub>w</sub>**) in tens, units and tenths of a degree Celsius.

## Cloud Data

Section 8 (Table 1-9) reports cloud information in one group following the 41414 indicator group. The **N<sub>h</sub>C<sub>L</sub>hC<sub>M</sub>C<sub>H</sub>** is the cloud group. The **N<sub>h</sub>** is the sum of all the low-etaage clouds present, or if no low-etaage clouds are present, the sum of all the mid-etaage clouds present, in oktas (WMO Code Table 2700), and **h** is the coded height above the surface of the lowest cloud layer (WMO Code Table 1600). The **C<sub>L</sub>**, **C<sub>M</sub>**, and **C<sub>H</sub>** represent, respectively, the predominant type of low-, mid-, and high-etaage clouds from WMO Code Tables 0513, 0515, and 0509.

## Regional Codes

Regional codes are added to the international code following the regional code indicator groups. In WMO Region IV, the required regional codes are specified in the FMH-3. In Region IV, all regional data is reported in "additional" data groups, commonly called the 101-groups, following the 51515 Regional code indicator. Other countries may use different regional codes following any of the other regional code indicator groups 52525, 53535, . . . , 59595, and national codes 61616, 62626, . . . , or 69696. Regional and national codes for other countries are found in WMO Publication 306, Manual On Codes, Volume II, *Regional Codes and National Coding Practices*.

The 101 -groups are five-digit groups following the format 101 **A<sub>dr</sub>A<sub>dr</sub>**. The **A<sub>dr</sub>A<sub>dr</sub>** indicates the type of data being reported as listed in table 1-6. Actual data may follow a "101-group" in additional code figure groups. Only data pertaining to the sounding below the 100-hPa level is reported with 101-groups in Part B. These groups can be used to report doubtful data, corrected data, or early transmission data. If the sounding terminates below the 100-hPa level, the reason for termination is also entered in this section.

## PART C - UPPER MANDATORY LEVELS

Part C of the TEMP codes contains reports for mandatory levels above the 100-hPa level. The mandatory levels reported in this section are the 70-hPa, 50-hPa, 30-hPa, 20-hPa, and 10-hPa levels. This section uses the same format as Part A of the TEMP code message, including identification data, mandatory level data for the levels above 100 hPa, tropopause data



(if located higher than 100 hPa), and maximum wind data (if located higher than 100 hPa).

If the upper-air sounding terminated below the 100-hPa level. Part C of the message may be encoded and transmitted including only the appropriate identification data followed by the code 51515 and the reason for termination code.

## **PART D - UPPER SIGNIFICANT LEVELS**

Part D is used to report significant temperature and humidity levels, significant wind levels, and regional codes in the same manner as reported in Part B. Section 7, for sea-water temperature and the rawinsonde system information. and section 8. for cloud information, are never included in Part D. Coded regional information, such as the 101 -groups. are included as appropriate for any levels above 100 hPa.

## **EARLY TRANSMISSION MESSAGES**

Early Transmission messages are brief reports of certain observed upper-air data. which are sent as soon as possible after the radiosonde measures the 500-hPa level. Normally, these messages are manually encoded by all ships and designated synoptic land stations while the MRS continues to receive and process data. These messages contain only the appropriate Part B identification data, followed by, the code groups 51515 10196 and data for the 850-, 700-. and 500-hPa levels (as normally transmitted in Part A). Land stations may also include the stability index and the low-level mean winds. The 10196 group identifies the data as an "early report."

In addition to encoding Parts A through D of the TEMP code, certain stations must encode some data in the PILOT code, which is discussed in the following text.

### **REVIEW QUESTIONS**

- Q56. What Information is contained in Part B of a TEMP coded message?*
- Q57. What information is contained in section 8 in Part B of a TEMP coded message?*
- Q58. The 21212 indicator group is followed by what type of information?*
- Q59. How are boundaries of missing data encoded in Part B?*

- Q60. How should the following data "31313 46105 82325 90173" be decoded?*
- Q61. In what part of a TEMP coded message would you expect to find data for the 70-hPa level?*
- Q62. Early Transmission messages report information up to what level?*

## **PILOT CODE**

---

*LEARNING OBJECTIVES:* Identify the three forms of the PILOT code and explain the use of each form. Identify the type of information contained in each message part and the meaning of each coded element. Describe the special use of the PILOT code for Rawinsonde observations conducted within WMO Region IV.

---

The PILOT code is primarily used throughout the world to report PIBAL-observed wind directions and speeds. In the United States, it is also used to report fixed regional level winds observed during a Rawinsonde observation.

Like the TEMP code, the PILOT code is also separated into four parts to ease handling and speed transmission. Parts A and C include winds observed at the standard altitudes for the mandatory pressure levels. Parts B and D include winds for the significant wind levels. Parts A and B are for levels from the surface to 100-hPa (about 53,000 feet), while Parts C and D are for levels above the standard 100-hPa level. Each part begins with an identification Data section.

There are three forms of the PILOT code prescribed for use by the WMO. WMO code FM 32-1X PILOT is used by designated shore stations to report upper-air observations of wind information. The code identifiers PPAA, PPBB, PPCC, and PPDD are used to identify this code form. FM 34-1X PILOT MOBIL is used by mobile sites ashore to report atmospheric wind observations. The code identifiers EEAA, EEAB, EECC, and EEDD are used to identify this code. At sea, shipboard upper-wind observations are reported in WMO code FM 33-1X PILOT SHIP using the identifiers QQAA, QQBB, QQCC, and QQDD. Each code form is nearly identical in format except for the identification information contained in the first line of each message part.

## IDENTIFICATION DATA

The identification data contains the data type, the location identifier and/or location, and the date-time group. The format is identical to the TEMP code, Part B:  $M_i M_i M_j M_j$  YYGGa<sub>4</sub> IIII is used with the PILOT code, while PILOT SHIP and PILOT MOBIL use  $M_i M_i M_j M_j$  D....D YYGGa<sub>4</sub> 99L<sub>a</sub>L<sub>a</sub>L<sub>a</sub> Q<sub>c</sub>L<sub>o</sub>L<sub>o</sub>L<sub>o</sub>L<sub>o</sub> MMMU<sub>La</sub>U<sub>Lo</sub> h<sub>o</sub>h<sub>o</sub>h<sub>o</sub>h<sub>o</sub>i<sub>m</sub>. The same identification data format is used in all four parts of the report.

## PART A - LOWER MANDATORY LEVELS

Part A of the message contains identification data; mandatory level winds. and the maximum wind and wind shear values.

### Mandatory Level Winds

After the identification data, the first section of the PILOT code Part A is the winds at the mandatory levels in the format 44nP<sub>1</sub>P<sub>1</sub> or 55nP<sub>1</sub>P<sub>1</sub> dffff dffff dffff. The 55nP<sub>1</sub>P<sub>1</sub> group is used only when the altitudes of the pressure levels are based on standard altitudes above mean sea level. The 44nP<sub>1</sub>P<sub>1</sub> group is used when the altitudes are obtained from pressure equipment, such as a radiosonde. This cluster of four five-digit groups, reporting winds at three mandatory levels, is repeated four times to include all the mandatory levels through the 100-hPa level.

In the first group, the *n* indicates the number of standard levels reported in the section and the number of dffff groups that follow. This figure is usually a 3, but may be a 1 or 2 in the last repetition. The P<sub>1</sub>P<sub>1</sub> is the hundreds and tens value of the first pressure level reported.

The dffff group reports wind directions (dd) and wind speeds (fff). As in the TEMP code, the units of wind speed are meters per second if the date, YY, in the identification data is simply the UTC date. When the wind speed units are reported in knots, 50 is added to the date. All wind directions in the PILOT code are reported to the nearest 5 degrees.

*For* example, the coded groups 43300 09535 08058 06601 indicate winds at three pressure levels (from a radiosonde), starting at the 1,000-hPa level ("00"). 095° at 35 knots; the 925-hPa level. 080° at 58 knots; and the 850-hPa level. 065° at 101 knots.

## Maximum Wind

The following five different formats are used for the indicator group of the level of maximum wind or a secondary level of maximum wind:

66P<sub>m</sub>P<sub>m</sub>P<sub>m</sub>—maximum wind at top of sounding, measured pressure level reported.

6H<sub>m</sub>H<sub>m</sub>H<sub>m</sub>H<sub>m</sub>—maximum wind at top of sounding, standard altitude reported in meters.

77P<sub>m</sub>P<sub>m</sub>P<sub>m</sub>—maximum wind within sounding, measured pressure level reported.

7H<sub>m</sub>H<sub>m</sub>H<sub>m</sub>H<sub>m</sub>—maximum wind within sounding, standard altitude reported in meters.

77999—no maximum wind observed.

The P<sub>m</sub>P<sub>m</sub>P<sub>m</sub> is the measured pressure level in hectopascals and H<sub>m</sub>H<sub>m</sub>H<sub>m</sub>H<sub>m</sub> is the altitude in decameters (units rounded off, hundred-thousands value not reported). A maximum wind level must have a wind speed in excess of 60 knots and occur above the 500-hPa level. A secondary maximum wind level may also be reported.

Following the maximum wind indicator group, the wind is reported in the format dffff, and the optional vertical wind-shear group, 4v<sub>b</sub>v<sub>b</sub>v<sub>a</sub>v<sub>a</sub>, may be reported the same as in the TEMP code.

## PART B - LOWER SIGNIFICANT LEVELS

This part of the PILOT code message contains identification data, reports of winds at significant levels, and regional and national coded information for the levels up through 100 hPa. In WMO Region IV, the fixed regional levels (PPBB) replace any significant levels (section 6, Part B of TEMP Code).

### Significant Level Winds

When only significant levels are reported, as indicated by the identifier group 21212, each level is encoded in two five-digit groups in the format nnPPP dffff. The nn indicates the level (number 00 for surface, and then upward from 11 through 99, and repeating as necessary). The PPP is the pressure for the level. The dffff is the wind direction and speed, just as reported for the mandatory levels.

### Fixed Regional Level Winds

When this section is used to report winds at fixed regional levels, a slightly different format is used. The

21212 indicator group is not included. Winds are encoded in sets of three fixed levels, from lower to higher. Each set is preceded by an identifier group  $9t_n u_1 u_2 u_3$  or  $8t_n u_1 u_2 u_3$ . Identifier groups beginning with a 9 are used when the fixed levels are separated by 300 meter (1,000 foot) increments, as used in WMO Region IV. An indicator "1" replaces the indicator "9" when the heights exceed 30,000 meters (100,000 feet). The "8" indicator means that the fixed levels are separated by 500-meter increments. The  $t_n$  is the tens digit of the first altitude reported in the set; the  $u_1$ ,  $u_2$  and  $u_3$  are the units digits of the level number.

Essentially, as used by the United States,  $t_n$  is the ten-thousands value of the altitude in feet, and the  $u_1$ ,  $u_2$ , and  $u_3$  are the thousands value of the altitude in feet. For example, "91246 27575 27090 26606" indicates winds for the 12,000 foot (MSL), 14,000-foot (MSL), and the 16,000-foot (MSL) fixed regional levels, respectively, as 275° at 75 knots, 270° at 90 knots, and 265° at 106 knots. Refer to table 1-5 for a listing of the fixed regional levels used in WMO Region IV.

### Regional Codes

Regional codes may be added to the report following the "51515" through "59595" group and national codes from "61616" through "69696" indicator group, as appropriate. In WMO Region IV, only the 51515 group is used. The Additional Data Codes or 101-groups, as discussed previously, may be added when encoding a Pibal observation. The indicator and the 101 -groups are not included when using the PILOT code Part B (or Part D) to report fixed regional level winds observed during a rawinsonde observation, since this would duplicate information previously transmitted.

### PART C - UPPER MANDATORY LEVELS

Part C of the PILOT code is formatted exactly as Part A. Only the mandatory levels above the standard altitude of the 100-hPa level are reported in Part C.

### PART D - UPPER SIGNIFICANT LEVELS

Significant level winds or fixed regional level winds for the levels higher than the 100-hPa level are reported in Part D. The format is exactly the same as Part B.

### REVIEW QUESTIONS

Q63. *What information is contained in Part A of the PILOT code?*

Q64. *What does the identifier EEBB of the PILOT code indicate?*

Q65. *How would the information "44370 33030 35565 32082" be decoded from Part A of a PILOT coded message?*

Q66. *The group  $77P_m P_m P_m$  is used to indicate what information in a PILOT coded message?*

Q67. *What is the minimum wind speed required for a wind level to be classified as a maximum wind?*

Q68. *When reporting fixed regional level winds in Part B of the Pilot Code, how would "90346 09012 10015 12520" be decoded?*

Q69. *What information is contained in Part D of the PILOT code?*

### OBSERVATION RECORDS

---

*LEARNING OBJECTIVES:* Identify the records that must be maintained by upper-air observers, and explain the proper disposition of these records.

---

SECNAVINST 5212.5, the *Navy and Marine Corps Records Disposition Manual*, identifies meteorological records, such as upper-air observations (except those conducted only for training), as permanent official records of the U.S. Government. As such, the original sounding records must be forwarded to FNMOD, Asheville, North Carolina, at the end of each month in accordance with NAVMET-OCCOMINST 3140.1, *United States Navy Meteorological and Oceanographic Support System Manual*. Duplicate copies of sounding records are temporary records that may be retained on board as long as they are useful, normally 1 year, and then destroyed.

### PAPER RECORDS

When an upper-air sounding is conducted by using the MRS, the sounding records are considered to be the original printouts of the raw data, the printouts of the mandatory and significant levels (LIST), and the printout of the coded message (TEMP), including any operator entered data. The printout should be neatly folded in standard page size (8.5 by 11 inches) and mailed in a large envelope. DO NOT separate the continuous feed printer paper into individual sheets. Each sounding printout should be arranged in chronological order and identified with complete

station identification and sounding identification information. Such information includes the following:

- Ship/mobile team/or station's name
- ICAO (shore), IRCS (ship)
- Mobile team or ship's latitude and longitude
- Elevation of release
- Scheduled observation time, day, month, year and actual time of release
- Radiosonde number
- Any remarks

Most of these items are automatically entered on the MRS printout.

### **DATA DISKETTE RECORDS**

Every effort should be made to download upper-air observation data directly to floppy diskette for submission to FNMOD, Asheville, North Carolina. This is a much easier process, and the data is more rapidly archived. It also eliminates the storing of paper forms. Ensure the diskette is labeled with the data type (upper-air data), the station name and ICAO or IRCS, and the date/time of the data. Also ensure the disk is write protected.

Additionally, all upper-air observing units should maintain an *Environmental Meteorological Sounding (EMS) Log* file or book for all soundings, including training. The log should indicate, at the minimum, the instrument serial number, the date and time of release, the latitude and longitude, and elevation of release (for mobile units or ships), the size balloon used, how much gas was used to fill the balloon, the altitude of the sounding at termination, the reason for termination, and

the time it took the radiosonde to reach the termination level. Information about which Omega stations were used, the surface weather, and remarks may also be included.

Completed logs and duplicate copies of sounding records serve several useful purposes. They may be used for research or equipment evaluation, and as justification for budget requests.

### **REVIEW QUESTIONS**

*Q70. Where are upper-air observation records sent at the end of each month?*

*Q71. What information from an upper-air observation must be forwarded for archive purposes?*

*Q72. What is the purpose of maintaining an Environmental Meteorological Sounding (EMS) log?*

### **SUMMARY**

In this chapter, we have discussed the different types of upper-air observations and the equipment in use by the Navy and Marine Corps. We also described the basic procedures for conducting Rawinsonde and Pibal observations. We then covered the two primary code forms used to report Rawinsonde and Pibal-observed information, and introduced you to the other upper-air reporting code forms in international use. Next, we explained how, by national practice, the United States reports fixed regional level winds in the PILOT code in addition to reporting the usual information in the TEMP code. Finally, we discussed the disposition of upper-air observation records.

# ANSWERS TO REVIEW QUESTIONS

- A1. *The troposphere and the stratosphere.*
- A2. *Pressure, temperature, relative humidity, and winds.*
- A3. *Upper-air soundings are used as primary input to upper-air computer forecast products, as well as for climatological and atmospheric research. They are also used extensively for local forecasting,*
- A4. *A radiosonde observation measures pressure, temperature, and relative humidity only, while a rawinsonde observation measures these parameters in addition to wind data.*
- A5. *Rawinsonde and Pibal observations.*
- A6. *A dropsonde observation.*
- A7. *Federal Meteorological Handbook No. 3 (FMH-3).*
- A8. *To determine wind vector information.*
- A9. *Helium and hydrogen.*
- A10. *100-gram and 300-gram balloons.*
- A11. *The neck.*
- A12. *When the balloon has been stored in cold temperatures or is older than 1 year.*
- A13. *Between 900 to 1,000 feet per minute.*
- A14. *To reduce the pressure (flow rate) of a gas into the balloon in order to prevent damage to the balloon.*
- A15. *About 40 cubic feet.*
- A16. *Additional gas should be added to increase lift.*
- A17. *Never.*
- A18. *To protect and securely hold the balloon when launching in high wind conditions.*
- A19. *With an 18-volt battery.*
- A20. *The radiosonde frequency can be adjusted by using a small screwdriver to turn a tuning screw located on the outside of the radiosonde unit.*
- A21. *By displaying 5 asterisks (\* \* \* \* \*) on the LCD.*
- A22. *The Officer of the Deck (OOD).*

- A23. *The surface observation should be compared to the surface data from the radiosonde as a prelaunch check.*
- A24. *A pressure increase or failure of the pressure to decrease, or long periods of missing data.*
- A25. *The "LIST" program.*
- A26. *The level was selected as significant due to changes in the relative humidity.*
- A27. *To ensure an accurate representation of the vertical profile of the atmosphere at the time of the sounding.*
- A28. *A wind direction change of 10 degrees or more provided the wind speed is greater than 10 knots.*
- A29. *U.S. Navy ships*
- A30. *RI indicates refractive index values (N-units) and MRI indicates modified refractive index values (M-units).*
- A31. *The 101 -indicator groups are used to report additive data such as the reason for termination, corrected data, and sections of doubtful data.*
- A32. *To conduct low-level wind observations used for tactical fixed-wing and rotary aircraft operations, and paradrop operations.*
- A33. *A theodolite.*
- A34. *From the change in the horizontal position of the balloon, and then computed either manually by using a Winds Aloft Computation sheet and aplotting board, or automatically by using a calculator or computer program.*
- A35. *The Federal Meteorological Handbook (FMH-3).*
- A36. *Geophysics Fleet Program Library (GFMPPL).*
- A37. *A white balloon.*
- A38. *The upper-air code allows a large volume of data to be transmitted internationally by using only a small number of characters. The code also provides for rapid evaluation of data through the use of computers.*
- A39. *Mobile land sites*
- A40. *At the synoptic hours 00Z, 06Z, 12Z, 18Z.*
- A41. *The 00Z or 12Z synoptic hour, whichever is closest to sunrise.*

- A42. *Using latitude, longitude, and the Marsden square number.*
- A43. *Part A contains information on mandatory levels at and below 100 hPa, and Part C contains information on mandatory levels above 100 hPa.*
- A44. *To transmit available information from the lower levels of the atmosphere prior to completion of the entire observation.*
- A45. *Mandatory levels at and below 100 hPa from a ship upper-air sounding.*
- A46. *When the wind speeds in **an** upper-air observation are measured in knots.*
- A47. *The sounding is from a fixed land site. The date of the sounding is the 9th of the month at 12Z, and the wind speeds are in knots. Additionally, wind information is available to at least the 150-hPa level.*
- A48. *99270 71520 08872.*
- A49. *Part A contains pressure-altitude, temperature, dew-point depression, and wind direction and speed data for all mandatory levels up to 100 hPa. It also contains tropopause and maximum wind data.*
- A50. *1,397 meters is the altitude of the 850-hPa level.*
- A51. *When the dew-point depression is 6.0°C or greater.*
- A52. *Wind direction is reported to the nearest 5 degrees and wind speed is reported to the nearest whole knot (or meter per second).*
- A53. *The altitude of the 700-hPa level is 2,910 meters, the temperature is -9.1°C, the dew-point depression is 13, the wind direction is 335°, and the wind speed is 14 knots.*
- A54. *88.*
- A55. *Maximum wind is at 220 hPa at 075° at 102 knots, the absolute value of the vector difference 3,000 feet below is 05 and 3,000 feet above is 08.*
- A56. *Part B contains significant temperature and humidity levels. It also may also contain significant level winds, system status and observation time, sea surface temperature data, as well as cloud information and regional and national coded data groups.*
- A57. *The observed cloud data.*
- A58. *Significant level winds.*
- A59. *At least one additional level must be encoded between the lower and upper boundary layers of the missing data.*

- A60. *So far and infrared radiation corrected automatically by the MRS; Vaisala RS-80 MARWIN system is being used as well as VLF-Omega frequencies. The radiosonde was launched at 2325Z, and the seawater temperature is 17.3°C.*
- A61. *Part C.*
- A62. *500 hPa.*
- A63. *Lower mandatory wind levels and maximum wind data up to the 100-hPa level.*
- A64. *Lower significant wind levels (or fixed regional wind levels) up to 100 hPa, reported by a mobile land station.*
- A65. *The winds at 700, 500, and 300 hPa are 330° at 30 knots, 355° at 65 knots, and 320° at 82 knots. respectively.*
- A66. *Maximum wind occurred within the sounding and is reported at a measured pressure level.*
- A67. *61 knots*
- A68. *The winds at the 3,000-ft. 4,000-f, and 6,000-ft levels are 090° at 12 knots, 100° at 15 knots, and 125° at 20 knots, respectively.*
- A69. *Upper significant level or fixed regional level winds above the 100-hPa level.*
- A70. *FNMOD, Asheville, North Carolina.*
- A71. *All raw data, in addition to the mandatory and significant level data (LIST), and the coded message output (TEMP).*
- A72. *EMS logs assist in research and equipment evaluation as well as budgeting considerations.*



## CHAPTER 2

# BATHYTHERMOGRAPH OBSERVATIONS

### INTRODUCTION

In this chapter, we briefly review the basic properties that affect sound in seawater. We then discuss the various uses of bathythermograph data and the equipment used to obtain this data, particularly the AN/SSQ-61(A) bathythermograph set and the AN/BQH-7(A) oceanographic data system. Next, we discuss the evaluation of the bathythermograph trace. We explain how to use the international bathythermograph observation reporting code and also cover the disposition of observation records. We then complete the chapter by explaining how to decode messages received from drifting environmental buoys, another valuable source of oceanographic data.

### SEAWATER TRAITS AND DEFINITIONS

---

*LEARNING OBJECTIVE:* Identify the three basic properties of ocean water on which sound-path predictions are based.

---

Undersea Warfare (USW), which involves the detection and prosecution of hostile submarines, is one of the largest and most important missions of the U.S. Navy. One of the key factors that enable U.S. Navy submarines, surface ships, and aircraft to detect hostile submarines is our ability to predict the propagation path of sound in the ocean waters. This same knowledge also helps our submarines avoid detection by hostile ships and aircraft. Sound-path predictions are based on measurements of salinity, temperature, and depth in the ocean waters.

### SALINITY

Salinity changes in deep ocean areas occur so slowly that we may, in most cases, consider salinity a constant. Salinity measurements in each ocean have been determined by oceanographic research ships and are available in many data bases. Salinity measurements are not routinely needed or made by operational ships.

### TEMPERATURE

Temperature is by far the most important factor in determining sound propagation paths in the upper layers of the ocean. Surface and intermediate ocean-depth temperatures change more rapidly than in deep water, with the faster changes occurring at the surface. Hourly satellite observations allow all significant changes in sea surface temperature to be routinely monitored. However, significant changes in water temperature near the surface and at intermediate depths require ships and aircraft to routinely measure these temperatures at depths of up to 6,000 feet. Deep ocean waters change temperature so slowly that routine measurements are not required. Accurate data is available from oceanographic data bases that are updated by research ships and other sources.

### OCEAN DEPTH

Ocean depth is also important to USW operations since the pressure of seawater is the dominant factor affecting sound velocity in the deep layers of the ocean. Ocean depth also affects sound propagation paths, such as bottom bounce and convergence zone.

### REVIEW QUESTIONS

- Q1. What property affecting sound propagation in seawater is normally considered a constant?*
- Q2. What is the most important factor affecting sound propagation in the upper layers of the ocean?*
- Q3. What is the dominant factor affecting sound speed in deep ocean layers?*

### USE OF BATHYTHERMOGRAPH OBSERVATIONS

---

*LEARNING OBJECTIVES:* Identify the main uses of bathythermograph data. Identify when bathythermograph observations are conducted.

---

The measurement and recording of subsurface water temperature at various depths is called a bathythermograph observation. Bathythermograph observations are normally conducted only in ocean depths of 100 fathoms (600 feet) or greater. The abbreviation "BT" is often used for the term *bathythermograph*.

Although most bathythermograph observations are conducted by Sonar Technicians and Aviation Warfare Systems Operators, Aerographer's Mates may conduct these observations while deployed aboard ship with mobile environmental teams. A far larger number of Aerographers routinely receive and use the transmitted observation *reports* to produce a variety of acoustic analyses and forecasts for USW support and other mission briefings. The input of accurate realtime bathythermograph data is the critical factor in determining the sound velocity profile (SVP) of a particular ocean area. It is from the SVP that the presence or absence of various acoustic propagation paths can be determined and thus exploited.

In addition to direct warfare support, bathythermograph observations are also used to analyze the location and structure of ocean fronts and eddies. These observations are an important input to numerical oceanographic models that analyze and predict ocean currents, surface temperatures, and other features. Bathythermograph observations are also archived in climatological data bases used by acoustic predictions systems; they are also used by Research and Development (R&D) activities to develop new oceanographic and acoustic models.

To be consistent with other environmental observations, the World Meteorological Organization has set standard bathythermograph observation times as the synoptic hours—0000, 0600, 1200, and 1800 UTC. Operators should attempt to make all BT observations as close to a synoptic hour as possible. USW ships normally drop shipboard expendable bathythermograph (SXBT) probes every 6 hours, but may reduce observations to once per day when operating within the same area for more than 24 hours. At least one BT observation should be taken when a ship enters an area with a differing thermal structure, such as in the vicinity of ocean fronts, eddies, major river outflow areas, and differing water masses.

### REVIEW QUESTIONS

*Q4. What is the primary purpose of conducting bathythermograph observations?*

*Q5. What are some other important uses of bathythermograph data?*

*Q6. When should routine BT observations be conducted?*

## BATHYTHERMOGRAPH EQUIPMENT

---

*LEARNING OBJECTIVES:* Discuss the background and history of bathythermograph observations. Describe the basic operation and maintenance of the AN/SSQ-61(A) bathythermograph set and the AN/BQH-7(A) oceanographic data system.

---

Many different types of seawater temperature-measuring equipment are in routine use throughout the Navy. Ships and submarines conduct bathythermograph observations using both installed sensors and expendable bathythermograph probes. Aircraft deploy a sonobuoy called an airborne expendable bathythermograph (AXBT). An AXBT measures ocean temperature during the probes transit to the bottom and relays the information to the aircraft via radio signals. Aircraft use different types of recorders that will plot temperature/depth profiles. There are also many types of moored and drifting meteorological/oceanographic buoys that are equipped with a sensor cable ("tail") that can measure the ocean temperature at fixed depths. The following text discusses only shipboard bathythermograph systems.

### BACKGROUND AND HISTORY

Through the late 1950's, Aerographer's Mates conducted bathythermograph observations by lowering and recovering a cable-tethered bathythermograph probe over the side of the ship. A carbon-covered glass slide carried by the probe was removed and evaluated for each observation. In the 1960's, the electronic bathythermograph recorder AN/SSQ-56 system, using expendable bathythermograph probes, was introduced. Several system modifications were made over the years, the newest of which is designated the AN/SSQ-61(A). Beginning in late 1986, new construction surface ships began to receive the "next generation" of bathythermograph equipment, the AN/BQH-7(A) oceanographic data system. The AN/BQH-7A, also called a "bathythermograph/sound velocimeter," uses the same probes used by the AN/SSQ-(series) sets, but it

also uses an expendable sound velocity measuring probe. The "SSQ" systems will remain in use through at least the late 1990's.

The following text discusses the AN/SSQ-(series) systems, followed by the AN/BQH-7A system.

### AN/SSQ-(SERIES) BATHYTHERMOGRAPHS

All of the AN/SSQ-(series) bathythermograph sets are manufactured by the Sippican Corporation, and appear very similar. The most apparent difference is the style of launcher used. Changes in the recorder are mostly in the electronics.

The AN/SSQ-61A bathythermograph system is the latest modification, which consists of an RO-326B/SSQ-56 or a RO-326C/SSQ-56 bathythermograph data

recorder (fig. 2-1) and a MX-8577/SSQ-61 bathythermograph launcher (fig. 2-2). The "C" model recorder has an additional output circuit that allows for a direct connection to a remote recorder or an onboard acoustic data processor.

The AN/SSQ-60 system is almost identical to the newer SSQ-61 series except it uses an earlier model recorder, the RO-326A/SSQ-56, and a slightly different launcher. Some ships still use the older AN/SSQ-56A system, which also uses the RO-326 model recorder but an earlier model launcher, the deck-mounted MX-7594A/SSQ-56.

Since all of the SSQ series systems accept the standard expendable 1,500-foot-depth OC-14/SSQ-56

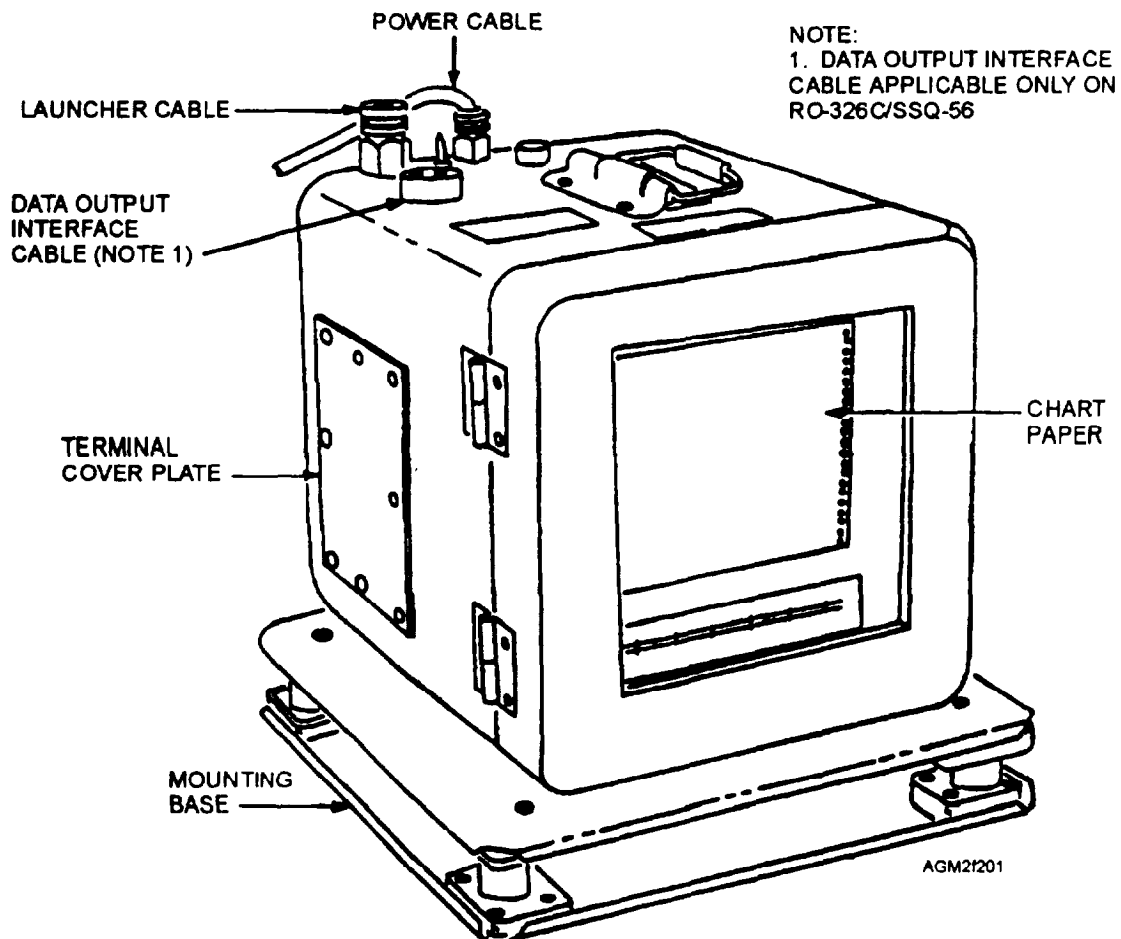

Figure 2-1.—Bathythermograph data recorder RO-326B, C/SSQ-56.

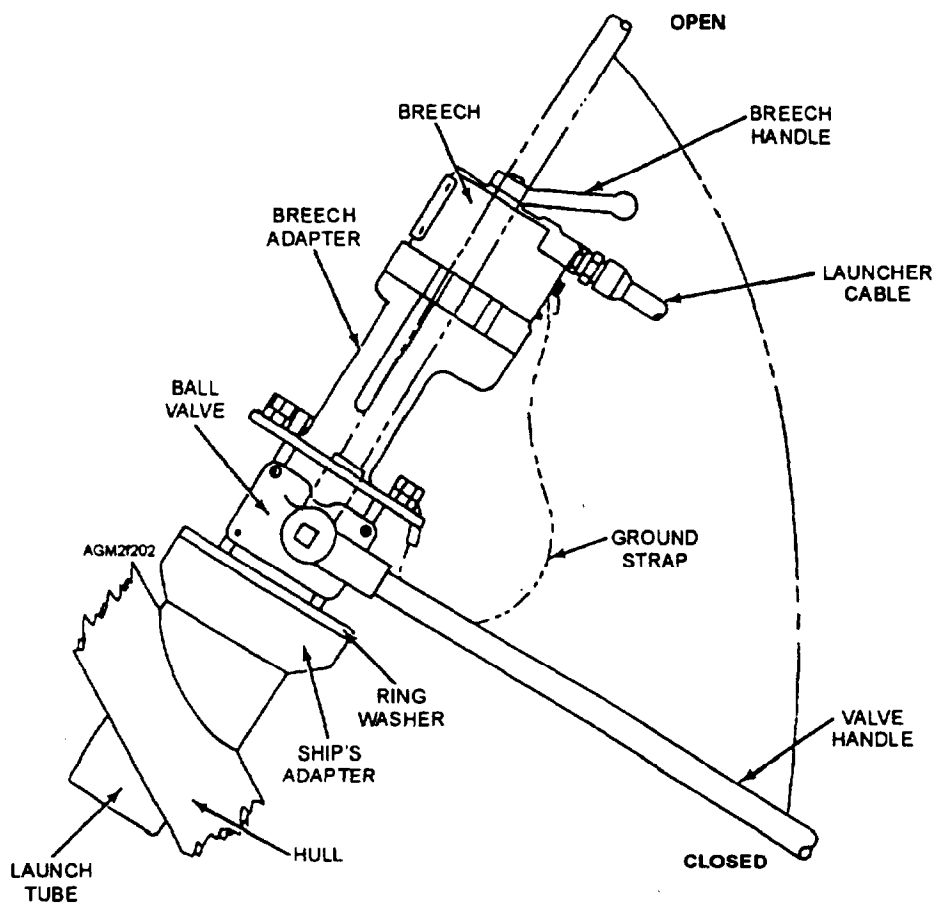

Figure 2-2.—MX-8577/SSQ-61 bathythermograph through-the-hull launcher.

bathythermograph probe (fig. 2-3), equipment components are all interchangeable. The standard probe is manufactured by the Sippican Corporation and is widely known as the T-4 probe, rather than as the OC-14/SSQ-56 probe.

An expendable bathythermograph probe is popularly called an XBT. An XBT consists of a probe with a thermistor installed in the nose and a canister. The probe descends at a known rate through the water, and the recorder converts the thermistor's electrical resistance (and descent time) into depth and temperature units. The thermistor is connected by a fine wire to contact pins mounted in the end of the canister, which is retained in the launcher during the measurement. When the measurement is completed, the wire breaks as the probe descends beyond the maximum depth of the probe. The canister is then removed from the launcher and discarded. A cable from the launcher connects to the recorder. Specific operation and maintenance instructions for each system are contained in the manuals cited in the reference list.

All recorders except the original RO-326 have changeable chart drive gears and an internal selector switch that allows operation with different types of probes. All systems most commonly use the T-4 probe.

### Basic Operation

An XBT observation may be conducted by one person, but it is much easier using two people with sound-powered telephones. One person should be stationed at the recorder (identified as "A") and the second person at the launcher (identified as "B"). With two people (A and B), the following sequence must be followed:

- "A": Turns on power at the recorder.
- "B": Opens launcher ball valve and breech (through-the-hull launchers).
- "B": Removes end cap from XBT, loads probe canister, and locks the breech.
- "A": Verifies automatic start sequence of recorder and chart alignment.

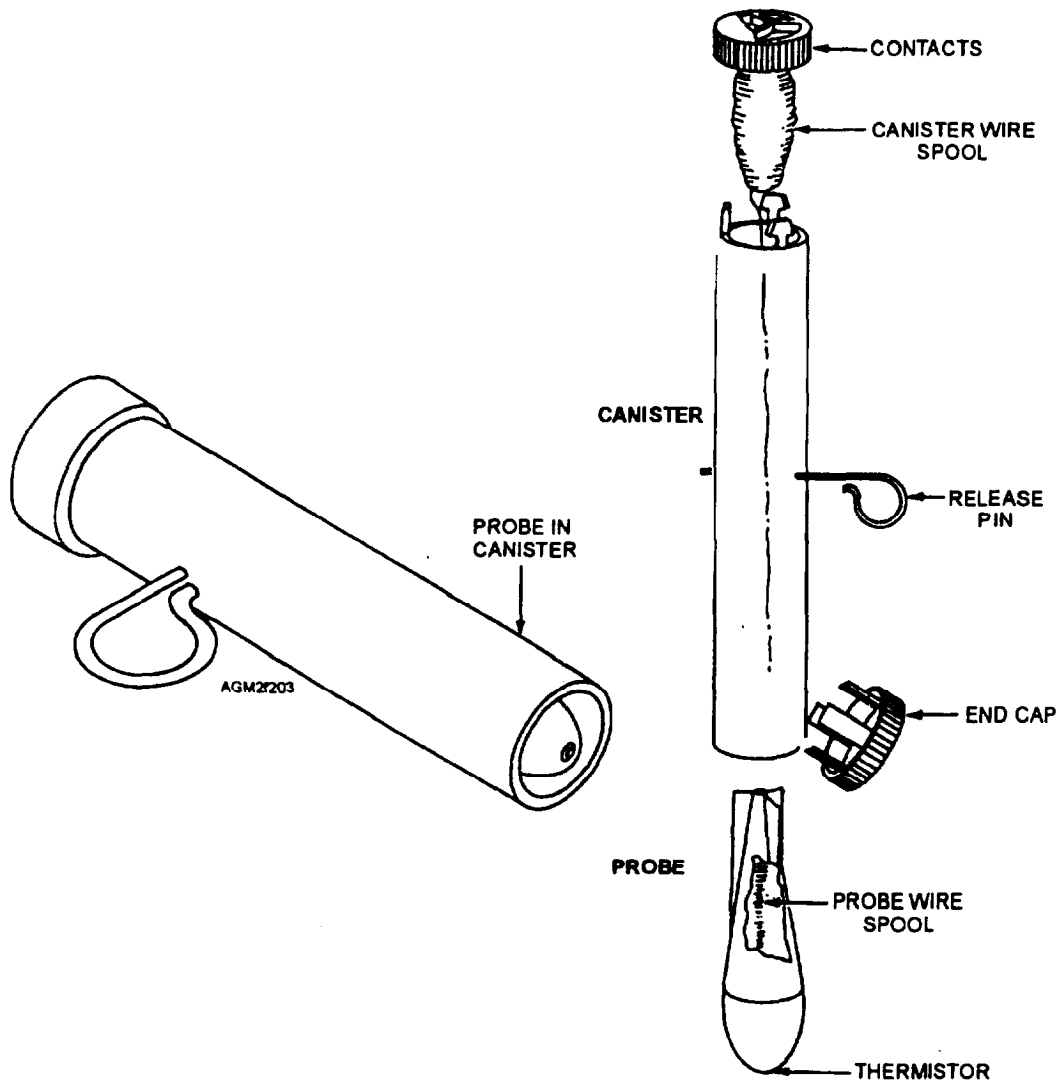

Figure 2-3.—XBT 1,500-foot-depth OC-14/SSQ-56 probe (Sippican T-4 probe).

- "B": Pulls pin out of canister to release probe.
- "A": Verifies proper recording operation.
- "B": After confirmed successful observation, removes canister and closes both ball valve and breech.
- "A": Evaluates trace (usually on the recorder), enters date/time, location, and identification data on the trace, and records/encodes data in the bathythermograph log.

### Maintenance

General maintenance requirements for each AN/SSQ-(series) system are covered on maintenance

requirements cards (MRCs) under the Ships' 3-M System, briefly discussed in module 1. Additional guidance may be found in the appropriate technical manuals. Some routine maintenance, such as checking and cleaning the launcher and test operating the recorder, may be done by the operator. Other maintenance requires the skills and special equipment of an Electronics Technician.

The operator normally leaves completed (and evaluated) observation recordings on the recorder after each sounding. The latest observation recording remains visible through the inspection window of the recorder case until the next observation is started. A standard chart roll records 200 observations. When the recorder chart runs out or when charts are removed, the paper must be reconnected to the take-up roller. Detailed instructions become visible on the recorder

when the recorder chart is removed. Replacement recorder charts are available in both feet/degrees Fahrenheit or meters/degrees Celsius. The metric rolls are recommended. No adjustment is needed to the recorder for either style chart. The ready-for-launch mode calibration temperature should be checked after placing a new chart on the recorder, as should the alignment of the stylus on the "surface" depth line. Figure 2-4 is an example of typical chart traces on the RO-326C/SSQ-56 data recorder.

## REVIEW QUESTIONS

- Q7. What is the maximum depth of the T-4 (OC-14/SSQ-56) probe?
- Q8. What are the three major components of the AN/SSQ-61A system?
- Q9. What does the abbreviation XBT mean?
- Q10. What two items must be checked after replacing a recorder chart roll on the RO-326C/SSQ-56 recorder?

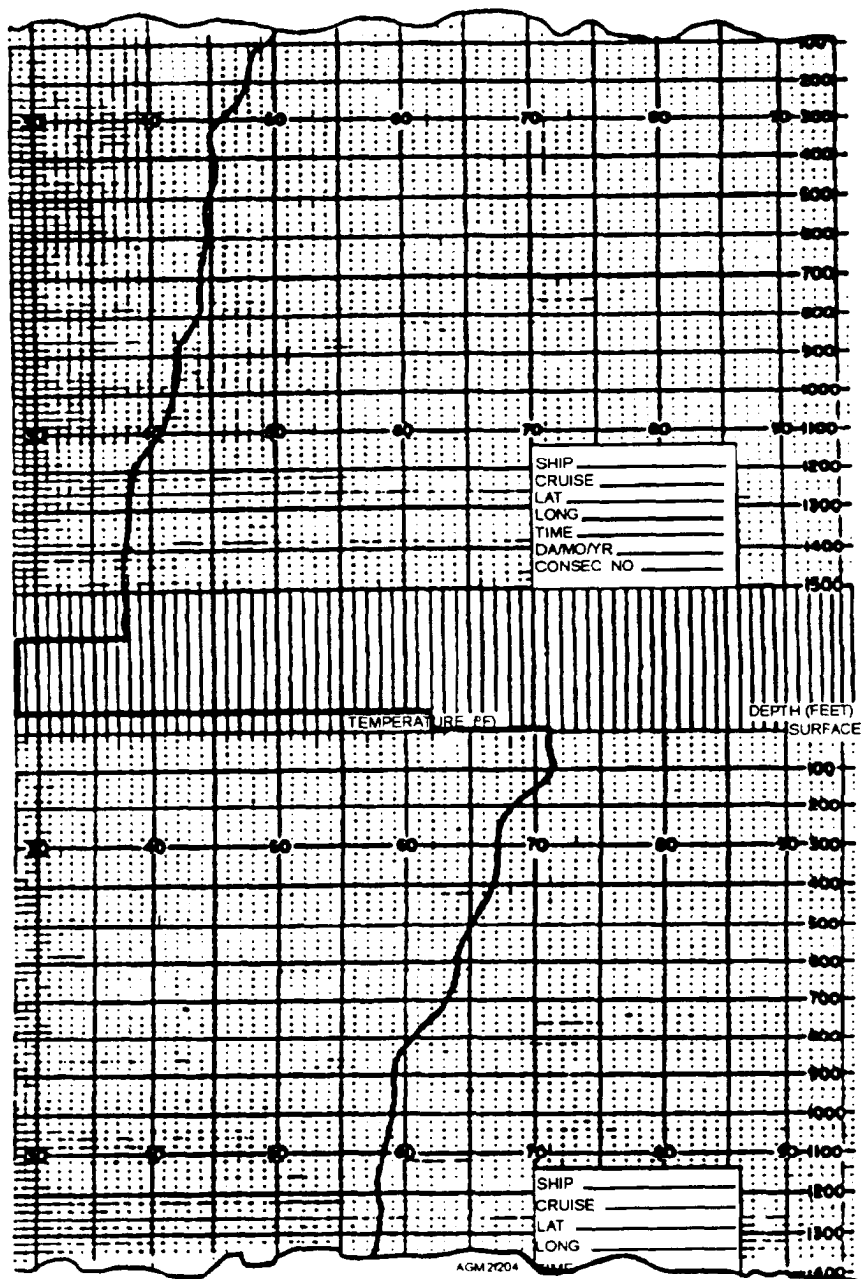
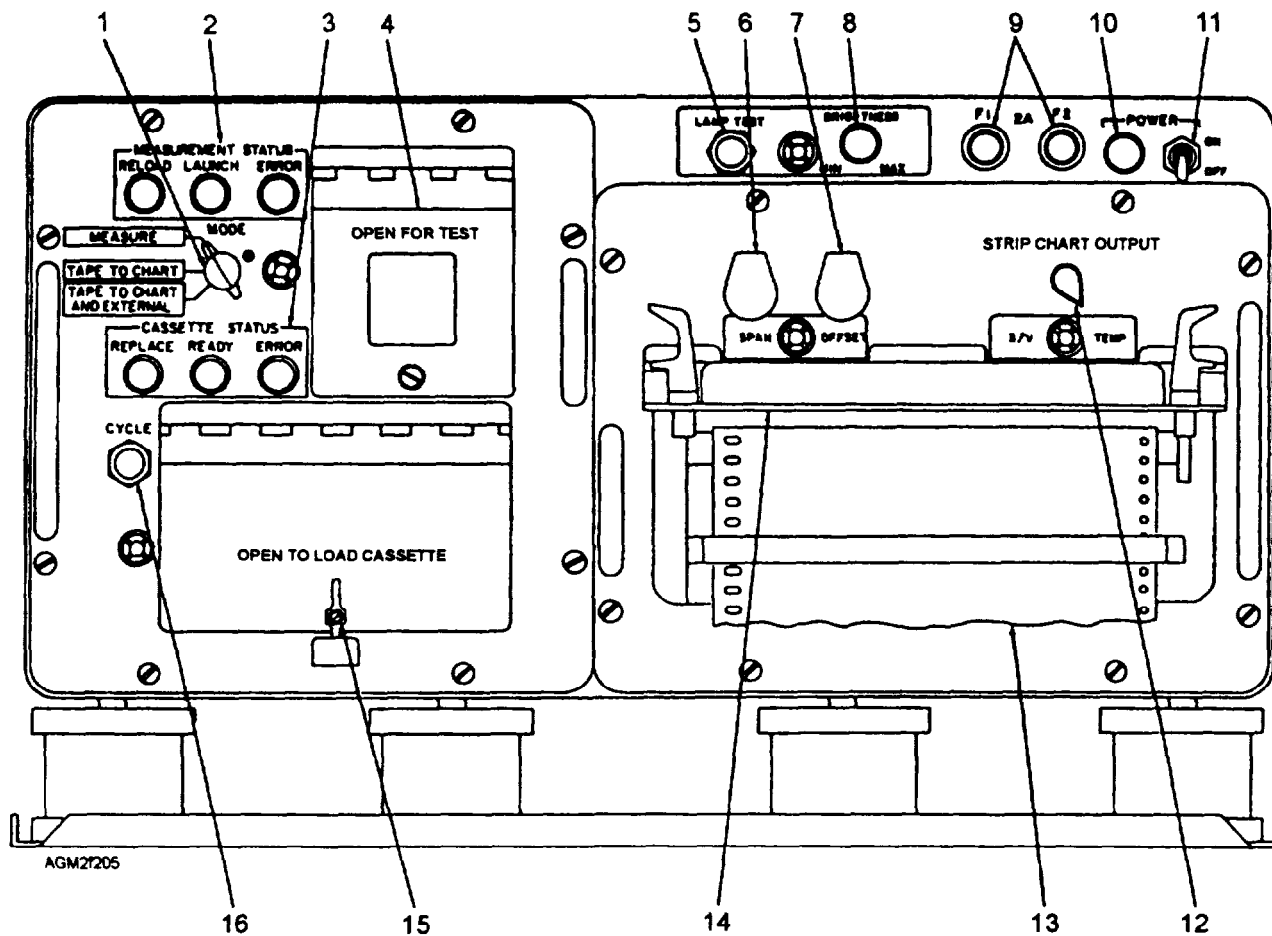

Figure 2-4.—Typical XBT chart traces on RO-326C/SSQ-56 recorder.



- |   |                                       |
|---|---------------------------------------|
| 1. MODE switch                                      | 9. Fuses                              |
| 2. MEASUREMENT STATUS lamps                         | 10. Power ON indicator lamp           |
| 3. CASSETTE STATUS lamps                            | 11. Power ON/OFF switch               |
| 4. Test control panel door                          | 12. STRIP CHART OUTPUT switch         |
| 5. LAMP TEST button                                 | 13. Chart paper                       |
| 6. SPAN adjustment (for chart "width" adjustment)   | 14. OPEN TO RECORD door               |
| 7. OFFSET adjustment (aligns stylus to chart paper) | 15. OPEN TO RECORD CASSETTE door      |
| 8. Lamp BRIGHTNESS Control                          | 16. CYCLE switch (recordings & tests) |

Figure 2-5.—AN/BQH-7A oceanographic data set recorder.

## AN/BQH-7(A) OCEANOGRAPHIC DATA SET

The AN/BQH-7A oceanographic data set recorder (fig. 2-5) looks very different from the AN/SSQ-(series) recorders. The recording chart paper feeds out of the chart door on the right front of the recorder; there is no take-up roll. Each chart recording must be removed from the recorder after each sounding, and the recorder door must be open during operation. As an additional feature, each sounding is also transcribed on cassette tape, which is inserted in the tape holder on the left front of the recorder.

### Basic Operation

The observation procedure is very similar to that of the AN/SSQ-(series) recorders. The "reload" light illuminates after each sounding. This light goes out and the "launch" light illuminates after a new probe is inserted in the launcher. Recording (both chart and tape) automatically starts as the probe enters the water.

Like the AN/SSQ-61A system, the BQH-7A also has an auxiliary signal output cable. The AN/BQH-7A auxiliary output is a digital signal designed for direct link-up to the shipboard Navy Tactical Data System (NTDS) computer. Where shipboard tactical

environmental software is interfaced with NTDS, shipboard Aerographer's Mates have indirect access to the bathythermograph output. On temporary deployment, mobile environmental team members may need to manually enter the bathythermograph output into the Mobile Oceanography Support System (MOSS) terminal.

The AN/BQH-7A may be connected to two launchers at the same time, although only one is used for each sounding. This system uses both a hand-held LM3A launcher (fig. 2-6) and the MX-8577/SSQ-61 through-the-hull launcher. The hand-held launcher may also be used with all of the AN/SSQ-(series) systems.

The same T-4 XBT probe is used with the AN/BQH-7A system. In addition, the AN/BQH-7A also accepts the T-5 6,000-foot-deep ocean scientific probe, the T-7 2,500-foot improved sonar prediction probe, and other specialized probes. By using any of these probes, you can make the chart recording as either a depth/temperature trace or as a depth/sound velocity trace. Selection is made with the "strip chart output" selector switch, located just above the chart door. Sound velocity is internally calculated based on the measured temperature and a standard salinity of 35%. The tape may be replayed to produce either a temperature or a sound velocity trace. Normally, the temperature trace is recorded first, evaluated and encoded for transmission, and then the sound velocity trace is recorded for direct use by the shipboard Sonar Technicians.

The AN/BQH-7A also uses a different type of probe called an Expendable Sound Velocimeter (XSV) probe. The standard model is the XSV-01, that conducts sound velocity measurements to 2,790 feet (850 meters), and is shown in figure 2-7. An XSV probe uses a special sensor that produces an internal acoustic signal. The integrated circuitry of the probe then calculates the sound speed, factoring in the temperature, pressure, and salinity of the water. The sound speed values produced by an XSV are direct measurements. When this probe is used, the chart output selector is disabled and only a sound velocity profile is produced. These probes are recommended in areas where the salinity of seawater is historically different from the standard 35%, and when salinity varies with depth. When soundings are conducted by using this type of probe, a standard temperature probe must still be dropped to fulfill data collection requirements.

Detailed operating procedures are covered in the operator/technical manual *Technical Manual for*

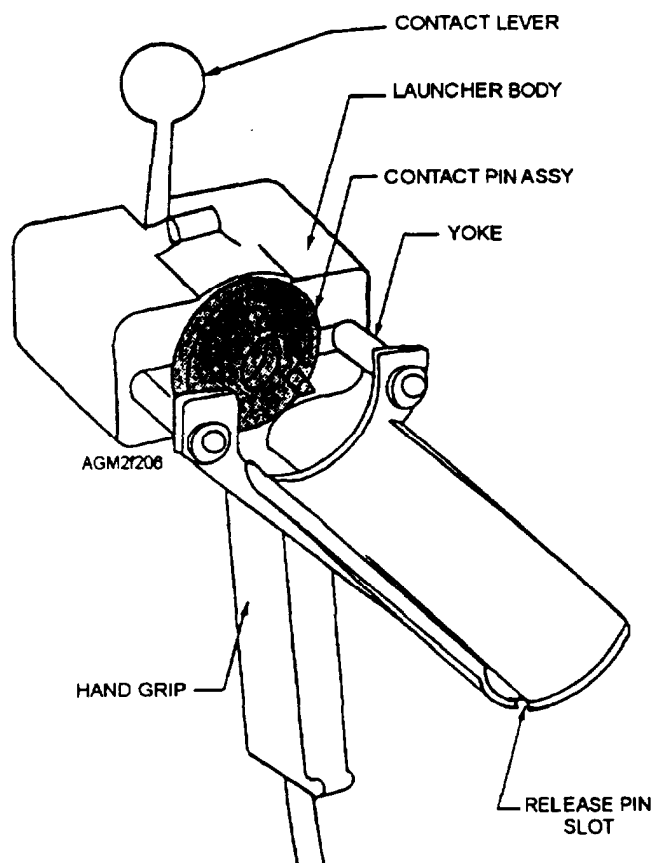

Figure 2-6.—LM3A hand-held launcher.

*Bathythermograph/Sound Velocimeter AN/BQH-7A Oceanographic Data System Surface Ship Application, NAVSEA SE365-BA-MMO-010/BQH-7A.*

### Maintenance

Preventive and corrective maintenance are thoroughly covered in the operator/technical manual. Preventive maintenance includes recommended **weekly** testing of the system output using a test probe, a **monthly** launcher cleaning and inspection, a **quarterly** test device performance procedure, a **semiannual** recorder and processor cleaning and inspection, and an **annual** check of the cable's signal/ground continuity and insulation resistance. At the beginning of each sounding, the operator must ensure that the ready-for-launch mode stylus alignment is made. With an XBT probe in the "temperature" mode, align the stylus at 62.0°F (±0.3°F). and with an XSV probe, align the stylus at 4,962 feet per second. Columns are predrawn on each recording chart for these readings as well as for other calibration measurements.



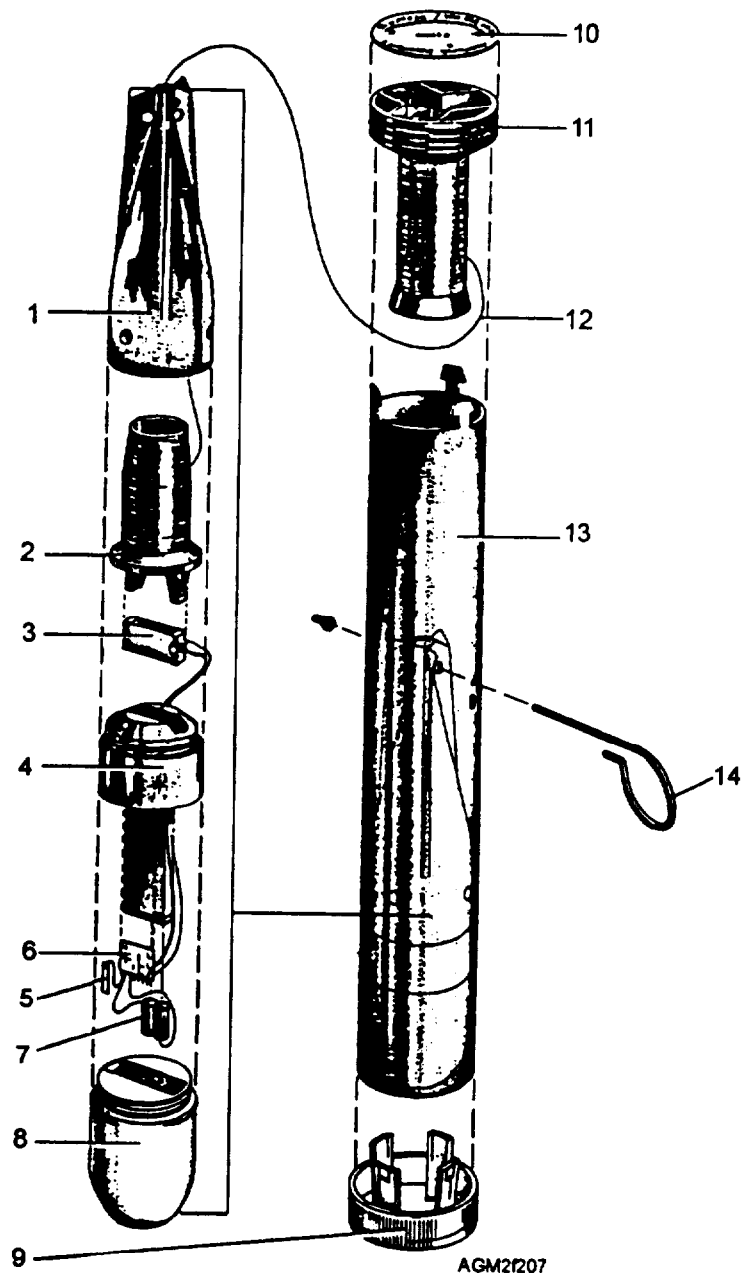

- |                          |                     |
|--------------------------|---------------------|
| 1. Afterbody             | 8. Zinc nose        |
| 2. Probe spool           | 9. Shipboard cap    |
| 3. Sound velocity sensor | 10. Label           |
| 4. Electronics housing   | 11. Shipboard spool |
| 5. Starting contact      | 12. Signal wire     |
| 6. Integrated circuit    | 13. Canister        |
| 7. Batteries             | 14. Retaining pin   |

Figure 2-7.—XSV-01 850-meter sound velocimeter probe.

Figure 2-8 shows an example of both a temperature trace and a sound velocity trace from the AN/BQH-7A recorder.

## EVALUATION OF SOUNDING TRACES

**LEARNING OBJECTIVES:** Recognize the anomalous recording indicators due to equipment malfunction and other unusual conditions in a bathythermograph observation. Describe how temperature and water depths are evaluated from a bathythermograph recording.

### REVIEW QUESTIONS

- Q11. What additional feature of the AN/BQH-7A bathythermograph system is an advantage over the AN/SSQ-61A system?
- Q12. What is the main purpose of the auxiliary output cable on the AN/BQH-7A?
- Q13. Besides temperature, what additional type of recording trace is produced by the AN/BQH-7A?
- Q14. What is the purpose of an Expendable Sound Velocimeter?

After the completion of a successful sounding, temperature and depth levels are selected for encoding and reporting. The temperature traces from all soundings must be evaluated for possible equipment malfunction prior to encoding the data. Temperature profiles from both types of recorders must also be examined for inconsistencies. Although the paper recording chart is slightly different, the indicators of

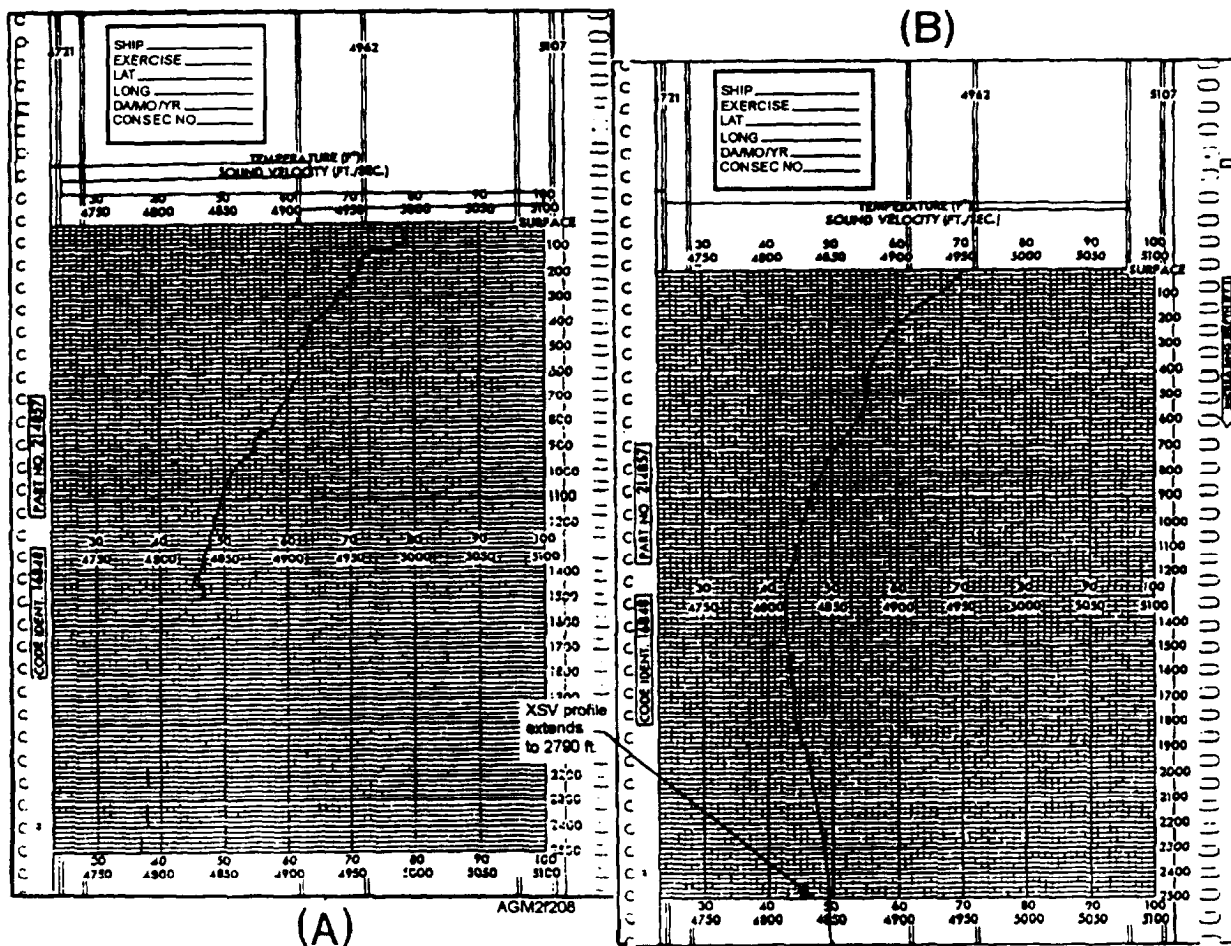

Figure 2-8.—AN/BQH-7A recorder stylus alignment in (A) temperature mode and (B) sound velocity mode.

malfunctions on both types of recorders appear basically the same. See table 2-1 for a listing of common malfunctions and corrective actions.

### EVALUATION OF ANOMALOUS FEATURES

Anomalous features detected in a recorder trace from either the AN/SSQ-56 (series) recorders or the AN/BQH-7(A) recorder may invalidate the observation. Another probe should be launched after the cause of the problem is identified and corrected. Although somewhat dated, the Naval Oceanographic Office Reference Publication, RP 21, *Guide To Common Shipboard Expendable Bathythermograph (SXB T) Recording Malfunctions*, identifies and explains the cause of many trace anomalies. This publication should be thoroughly reviewed by every operator.

Obvious equipment malfunctions normally occur in less than 10 percent of all launches. However, improper handling of the probes can cause a greater number of failures than normal. Rough handling or improper storage of probes can cause the flattening or compaction of the wire in the probe and canister spools, abrasion of the insulation on the wire, or tangles in the wire. These failures can be significantly reduced by storing the probes away from extreme temperatures and humidity. Probes should always be maintained in a vertical position with the protective cap (weighted end of probe) down.

When conducting an observation, the operator should be aware of the expected thermal characteristics in the area. Large variations in thermal structure is quite common in the vicinity of ocean fronts and eddies. If anomalous features are detected in the trace that cannot be attributed to a malfunction or to an expected thermal feature, a second probe should be launched.

### EVALUATION OF TEMPERATURE AND DEPTH

The evaluation of the temperature curve is a simple, straightforward matter. The observer must select significant levels on the temperature curve so that the entire curve may be reconstructed by connecting the selected points with straight lines. Temperatures are read to the nearest tenth of a degree (°C or °F) and to the nearest meter or tens of feet of depth.

#### Temperature Gradients

There are three terms that are used to describe the gradient (or trend) of the temperature trace on a bathythermograph chart. The first term is *positive temperature gradient*, and is defined as an increase in water temperature with depth. The next term, *negative temperature gradient*, is the opposite of positive temperature gradient, and is defined as a decrease in water temperature with depth. The last term is *isothermal gradient*. It is defined as no change in water

Table 2-1.—Common Malfunctions in Bathythermograph Recordings

SYMPTOM	CAUSE	CORRECTION
Stylus makes erratic excursions to the right of the chart paper.	Leak from probe wire to salt water.	Launch new XBT.
Stylus makes excursion all the way to left of chart paper and remains there.	Complete wire breakdown.	Launch new XBT,
Stylus makes erratic excursions to the left of chart paper.	Contamination, such as excessive salt water, between breech and canister.	Breech pins should be wiped thoroughly and new XBT inserted.
Recorder completely inactive, indicators not illuminated.	POWER switch to OFF or power cord unplugged. Fuse blown. INTERLOCK switch open.	Replace fuse.
HF radio transmission affect recorder stylus.	Electromagnetic interference.	Change capacitor.

temperature with depth. Figure 2-9 depicts the three types of temperature gradients as they would appear on a bathythermograph trace.

### Selection of Significant Data Points

Certain criteria have been established for selecting data points from a bathythermograph trace. Remember that the objective of selecting these points is to provide a fairly accurate representation of the temperature profile of the water column. The following points on a bathythermograph trace are always considered significant and must be reported:

- The surface (or the first readable temperature in the upper 10 meters or 30 feet).
- The Mixed Layer Depth (MLD).
- Tops and bases of isothermal layers.
- Inflection points in the trace; that is, significant points on the trace where the temperature changes from positive to negative or vice versa.
- The deepest point of the trace. If the BT strikes the bottom, be sure to encode the value using the 00000 indicator group.

Following these procedures, there should never be a need to report more than 20 points in the upper 500 meters (1,640 feet) of the trace. Once the significant levels are selected, the sounding may be entered into onboard computer systems for processing, and then encoded in the bathythermograph log. Figure 2-10 shows an unusual bathythermograph trace from an AN/SSQ-56 recorder. Significant levels have been selected.

Some airborne expendable bathythermograph (AXBT) systems produce digital printouts of

depth/temperature data vice actual depth/temperature traces. Although these can be difficult to work with, the same criteria is applied when selecting significant data points.

### REVIEW QUESTIONS

- Q15. What might cause the stylus on an AN/BQH-7A to make erratic excursions to the right on the recording chart?
- Q16. Other than equipment or probe malfunction, what might be the cause of anomalous features on a XBT recording trace?
- Q17. What term describes an increase in temperature with depth?
- Q18. What significant points on a BT trace must be evaluated and encoded?
- Q19. What is the maximum number of points that should be encoded in a BT observation report in the upper 500 meters (1640 feet) of the trace?

### ENCODING BATHYTHERMOGRAPH SOUNDINGS

*LEARNING OBJECTIVES:* Describe how elements observed during a bathythermograph sounding are properly encoded in the BATHY code. Identify the meaning of each element in the BATHY code.

The CNMOC 3167/2 Bathythermograph Log contains a foldout cover sheet with complete instructions for completing the log and encoding the observation in the proper International Code, which is WMO Code FM 63-X BATHY. The Bathythermo-

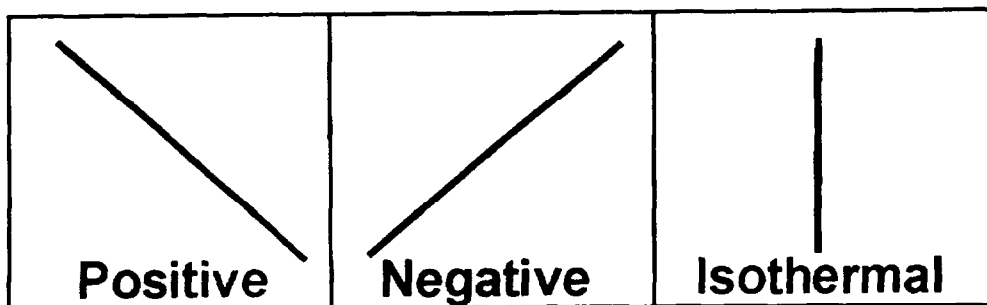

AGM21209

Figure 2-9.—Types of temperature gradients.

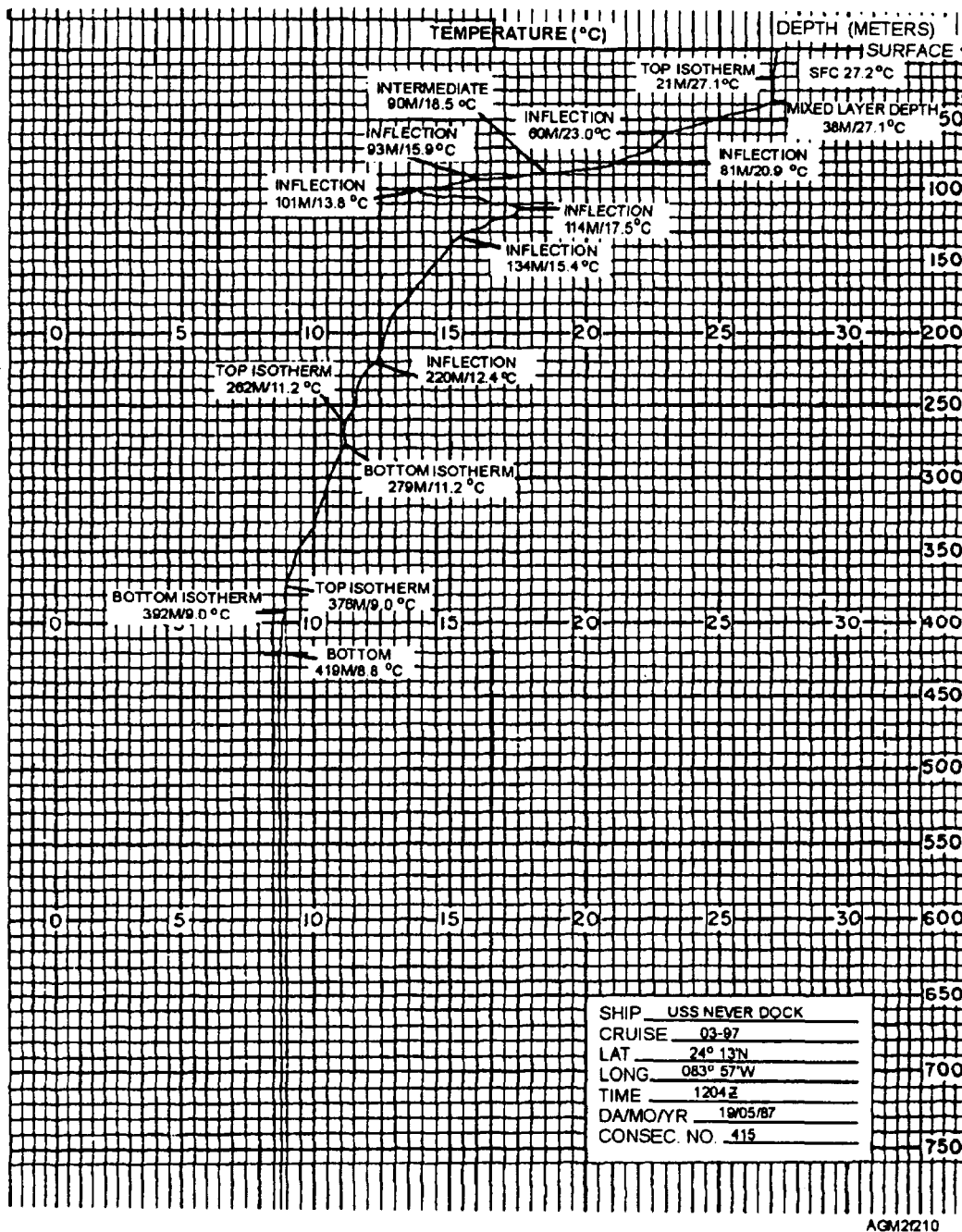

Figure 2-10.—An unusual AN/SSQ-56 recorder trace.

graph Log consists of three sections. Section I is used for reference/identification information; Section II is used for meteorological and other environmental information and also remarks; and Section III is used to

encode the observation. Each page of the log contains data blocks for three observations, as shown in figure 2-11. The first section has been filled in with the data obtained from the sounding in figure 2-10. Surface

# BATHYTHERMOGRAPH LOG

Prepared by the COMMANDER, NAVAL METEOROLOGY AND OCEANOGRAPHY COMMAND  
in accordance with specifications established by the  
WORLD METEOROLOGICAL ORGANIZATION (WMO)

FOR NAVY AIRCRAFT USE

FOR NAVY SHIP USE

SHIP TYPE		HULL NUMBER		YR	MON
B	A	CG	65	7	05
1	2	3-4	5	6	7

SOON TYPE		SOON NUMBER		SORTIE NUMBER		YR	MON
B	A						P
1	2	3-4	5	6	7	8	9

I. REFERENCE INFORMATION

PLATFORM	TYPE	NAME	DESIGNATOR
	COUNTRY	INSTITUTION	
CRUISE NUMBER	PROJECT		
STATION NUMBER	OBSERVATION NUMBER		
	INSTRUMENT		

II. OPTIONAL ENVIRONMENTAL INFORMATION

DEPTH TO BOTTOM (METERS)	WIND DIR		SPEED		SEA LEVEL PRESSURE		AIR TEMP DRY BULB		AIR TEMP WET BULB		
	L	d	d	i	P	P	P	P	T	T	
SEA TEMP °C		WAVE PER		SWELL DIR		SOLAR RADIATION		PRECIP		TRANS	
T <sub>1</sub>	T <sub>2</sub>	T <sub>3</sub>	P <sub>1</sub>	P <sub>2</sub>	H <sub>1</sub>	H <sub>2</sub>	D <sub>1</sub>	D <sub>2</sub>	P <sub>1</sub>	P <sub>2</sub>	M <sub>1</sub>

REMARKS:

I. REFERENCE INFORMATION

STATION NUMBER	OBSERVATION NUMBER	INSTRUMENT
----------------	--------------------	------------

II. OPTIONAL ENVIRONMENTAL INFORMATION

DEPTH TO BOTTOM (METERS)	WIND DIR		SPEED		SEA LEVEL PRESSURE		AIR TEMP DRY BULB		AIR TEMP WET BULB		
	L	d	d	i	P	P	P	P	T	T	
SEA TEMP °C		WAVE PER		SWELL DIR		SOLAR RADIATION		PRECIP		TRANS	
T <sub>1</sub>	T <sub>2</sub>	T <sub>3</sub>	P <sub>1</sub>	P <sub>2</sub>	H <sub>1</sub>	H <sub>2</sub>	D <sub>1</sub>	D <sub>2</sub>	P <sub>1</sub>	P <sub>2</sub>	M <sub>1</sub>

REMARKS:

I. REFERENCE INFORMATION

STATION NUMBER	OBSERVATION NUMBER	INSTRUMENT
----------------	--------------------	------------

II. OPTIONAL ENVIRONMENTAL INFORMATION

DEPTH TO BOTTOM (METERS)	WIND DIR		SPEED		SEA LEVEL PRESSURE		AIR TEMP DRY BULB		AIR TEMP WET BULB		
	L	d	d	i	P	P	P	P	T	T	
SEA TEMP °C		WAVE PER		SWELL DIR		SOLAR RADIATION		PRECIP		TRANS	
T <sub>1</sub>	T <sub>2</sub>	T <sub>3</sub>	P <sub>1</sub>	P <sub>2</sub>	H <sub>1</sub>	H <sub>2</sub>	D <sub>1</sub>	D <sub>2</sub>	P <sub>1</sub>	P <sub>2</sub>	M <sub>1</sub>

REMARKS:

III. RADIO MESSAGE INFORMATION  
a. METRIC Coding Example

1 MESSAGE PREFIX	2 DATE (UTC) DAY MONTH YR	3 TIME (UTC) HOUR MIN	4 LATITUDE DEG MIN	5 LONGITUDE DEG MIN	6 INDICATOR GROUP	7 INSTRUMENTS BT TYPE RECORDER
M M M M	Y Y M M J	C C 0 0	0 L L L L L	L L L L L L	0 0 0 0 0	L L L L L L
J J Y Y	19057	1204	72413	08357		0C102

BATHYTHERMOGRAPH TRACE READINGS

DEPTH TEMP	DEPTH TEMP	DEPTH TEMP	DEPTH TEMP	DEPTH TEMP	DEPTH TEMP	DEPTH TEMP
0 0 2 7 2	2 1 2 7 1	3 8 2 7 1	6 0 2 3 0	8 1 2 0 9	7 0 1 8 5	9 3 1 5 9
9 9 9 0 1	0 1 1 3 8	1 4 1 7 5	3 4 1 5 4	9 9 9 0 2	2 0 1 7 4	6 2 1 1 2
7 9 1 1 2	9 9 9 0 3	7 6 0 9 0	9 2 0 9 0	9 9 9 0 4		

1 MESSAGE PREFIX	2 DATE (UTC) DAY MONTH YR	3 TIME (UTC) HOUR MIN	4 LATITUDE DEG MIN	5 LONGITUDE DEG MIN	6 INDICATOR GROUP	7 INSTRUMENTS BT TYPE RECORDER
M M M M	Y Y M M J	C C 0 0	0 L L L L L	L L L L L L	0 0 0 0 0	L L L L L L
J J Y Y						

BATHYTHERMOGRAPH TRACE READINGS

DEPTH TEMP	DEPTH TEMP	DEPTH TEMP	DEPTH TEMP	DEPTH TEMP	DEPTH TEMP	DEPTH TEMP
	1 9 0 8 8	0 0 0 0 0	6 6 6 6 6	3 1 0 0 9		

b. ENGLISH Coding Example

1 MESSAGE PREFIX	2 DATE (UTC) DAY MONTH YR	3 TIME (UTC) HOUR MIN	4 LATITUDE DEG MIN	5 LONGITUDE DEG MIN	6 INDICATOR GROUP	7 INSTRUMENTS BT TYPE RECORDER
M M M M	Y Y M M J	C C 0 0	0 L L L L L	L L L L L L	0 0 0 0 0	L L L L L L
J J Y Y						

BATHYTHERMOGRAPH TRACE READINGS

DEPTH TEMP	DEPTH TEMP	DEPTH TEMP	DEPTH TEMP	DEPTH TEMP	DEPTH TEMP	DEPTH TEMP
0 0						

Figure 2-11.—Bathythermograph Observation Log.

ships, aircraft, and submarines all use the same code. Surface ships and some aircraft must take a surface weather observation at the same time the BT observation is made.

As an Aerographer's Mate, you will be required to encode or at least review bathythermograph data for dissemination. Besides its immediate operational use, BT data will also be used to develop oceanographic historical data bases. Therefore, it is imperative that a quality control check be conducted prior to transmission of the data.

Additional information on conducting and encoding bathythermograph observations is contained in OPNAVINST 3141.1, *Collection and Reporting of Bathythermograph Observations*, and in NAVMET-OCCOMINST 3140.1, *United States Navy Meteorological and Oceanographic Support System Manual*.

The symbolic format of the BATHY code is shown in table 2-2.

The bathythermograph code is sent as a single message composed of four sections of data. In table 2-2, groups in parenthesis are optional. Section 1 contains identification data and may contain meteorological data; section 2 contains the instrumentation and recorder type, and the depth/temperature information; section 3 reports water depth and surface current (optional); and section 4 is the ship or ocean station identifier.

### IDENTIFICATION DATA

The identification data section contains the mandatory data identifier; the year, month, and day group; the actual time of the observation; a latitude and longitude group; and the optional wind and air temperature groups.

The first group in section 1 is the data identifier, which is reported as "JJYY" for all ship, aircraft, and submarine BATHY observations.

A group not seen in many other codes is the YYMMJ. The YY is the UTC day of the month, while

**Table 2-2.—Symbolic Format of WMO Code FM 63-X BATHY**

SECTION	CODE FORM
1	JJYY YYMMJ GGgg/ or (GGgg9) Q <sub>c</sub> L <sub>a</sub> L <sub>a</sub> L <sub>a</sub> L <sub>a</sub> L <sub>o</sub> L <sub>o</sub> L <sub>o</sub> L <sub>o</sub> L <sub>o</sub> (I <sub>u</sub> ddff) (4s <sub>n</sub> TTT)
2	8888Kj I <sub>x</sub> I <sub>x</sub> I <sub>x</sub> X <sub>R</sub> X <sub>R</sub> Z <sub>o</sub> Z <sub>o</sub> T <sub>o</sub> T <sub>o</sub> T <sub>o</sub> . . . . Z <sub>n</sub> Z <sub>n</sub> T <sub>n</sub> T <sub>n</sub> T <sub>n</sub> 999zz Z <sub>n</sub> Z <sub>n</sub> T <sub>n</sub> T <sub>n</sub> T <sub>n</sub> (ooooo)
3	(66666 1Z <sub>d</sub> Z <sub>d</sub> Z <sub>d</sub> Z <sub>d</sub> k <sub>s</sub> D <sub>c</sub> D <sub>c</sub> V <sub>c</sub> V <sub>c</sub> )
4	D. . . .D or 99999 A <sub>1</sub> b <sub>w</sub> n <sub>b</sub> n <sub>b</sub> n <sub>b</sub>

MM is the month in two digits, and J is the last digit of the year. For example, "JJYY 22037" indicates that a BATHY observation was taken on the 22d day of March, 1997.

The time of the observation is encoded in group GGgg/ in UTC. The GG is the hour, and gg is the minutes after the hour. When the code is transmitted with depth and temperature reported in metric units (meters and degrees Celsius), the time is followed by a slant. If the operator is unable to convert observations from English units to metric units, the slant is changed to a 9. Navy bathythermograph operators will normally convert from English to metric units.

The latitude and longitude of the observation are reported in two groups, Q<sub>c</sub>L<sub>a</sub>L<sub>a</sub>L<sub>a</sub>L<sub>a</sub> and L<sub>o</sub>L<sub>o</sub>L<sub>o</sub>L<sub>o</sub>L<sub>o</sub>. The Q<sub>c</sub> is the quadrant of the globe using WMO code table 3333 (see appendix III); L<sub>a</sub>L<sub>a</sub>L<sub>a</sub>L<sub>a</sub> is the latitude in degrees and minutes; and L<sub>o</sub>L<sub>o</sub>L<sub>o</sub>L<sub>o</sub>L<sub>o</sub> is the longitude in degrees and minutes. This is the only code routinely used that reports latitudes and longitudes in degrees and minutes. All of the other codes report in degrees and tenths of a degree.

The optional wind group, i<sub>u</sub>ddff, is reported by most surface ships, but need not be reported by submarines and aircraft. The group starts with an indicator for wind speed, i<sub>u</sub>, found in WMO code table 1853. This is not the same indicator used for wind speed in the land and ship Synoptic codes (WMO Code 1855). Navy ships use only code figure 3 to indicate winds measured in knots in the bathythermograph code. Wind direction is reported in hundreds and tens of degrees in dd, and speed is reported to the nearest whole knot in ff.

NOTE: Instructions accompanying the log sheet state that i<sub>u</sub> should be encoded as a "0" (wind speed in meters) or a "1" (wind speed in knots). In the coded message, only a "3" (uncertified wind measuring instruments used) should be encoded as the first digit of the wind group.

Ships should also report the optional outside air temperature in group 4s<sub>n</sub>TTT. The 4 is the temperature indicator; s<sub>n</sub> is the temperature sign (0 for positive or zero, and 1 for negative temperatures); and TTT is the air temperature to the nearest tenth degree, usually in degrees Celsius. This group is not reported by submarines and aircraft.

Shipboard bathythermograph operators should report both wind and air temperature, and insert these code groups between data groups 5 and 6 on the form.

## DEPTH AND TEMPERATURE DATA

The largest part of the bathythermograph message, the reported significant depths and temperatures, follows the 8888k<sub>1</sub> indicator group. The last digit of the group, the k<sub>1</sub> indicator, is the “digitization” indicator (WMO Code Table 2262). This value is normally an “8” in bathythermograph observations taken from bathythermograph recorders, and means the reported depths are at significant levels. A “7” is reported when the depths/temperatures are reported at standard levels, such as 10, 50, or 100 meters.

A recent addition to the BATHY code is the group I<sub>x</sub>I<sub>x</sub>I<sub>x</sub>X<sub>R</sub>X<sub>R</sub>. The code figure I<sub>x</sub>I<sub>x</sub>I<sub>x</sub> is used to indicate the type of BT probe used and the fall rate equation coefficients of the probe. This group is encoded by using WMO International Code 1770, and is listed in Appendix IV. The code figure X<sub>R</sub>X<sub>R</sub> is used to indicate the recorder type used to conduct the observation and is based on WMO International Code 4770, also listed in Appendix IV.

**NOTE:** Instrument Codes 002, 032, 042, and 052 are not used with SIPPICAN MK2/SSQ-61 (Recorder Code 02) or SIPPICAN AN/BQH-7/MK8 (Recorder Code 04)

The code group z<sub>n</sub>z<sub>n</sub>T<sub>n</sub>T<sub>n</sub>T<sub>n</sub> is used to report each depth/temperature group selected as significant (z<sub>0</sub>z<sub>0</sub>T<sub>0</sub>T<sub>0</sub>T<sub>0</sub> indicates surface data). The z<sub>n</sub>z<sub>n</sub> is the tens and units digit of the depth in meters, or the hundreds and tens digit of the depth in feet if in English units. The T<sub>n</sub>T<sub>n</sub>T<sub>n</sub> is the tens, units, and tenths value of the temperature in degrees Celsius (or degrees Fahrenheit). Water temperatures below 0.0°C are indicated by adding 5 to the tens digit. A group 999zz is inserted in the code to indicate the hundreds value (thousands for English) of the depth for the groups that follow it. In this case, the zz is the hundreds units of the depth—encoded 01 for 100 meters, 02 for 200 meters, etc., and 15 for 1,500 meters. For example, significant depths and temperatures for “surface, - 1.1°C; 10 meters, 2.0°C; 24 meters, 4.5°C; 110 meters, 4.0°C; 150 meters, 4.9°C; and 340 meters, 4.3°C” would be encoded as follows:

JJYY 14027 1254/ 14224 15239 32617 41022 88888 00102  
00511 10020 24045 99901 10040 50049 99903 40043.

The same data in English units would be encoded as follows:

JJYY 14027 12549 14224 15239 32617 40280 88888 00102  
00301 03356 07401 36392 49409 99901 11397.

If the last depth and temperature reported is a bottom water temperature, the last depth/temperature group will be preceded by the indicator “00000.” This group is not reported if the probe stopped reporting before reaching the bottom.

## BOTTOM DEPTH AND SURFACE CURRENT

Section 3 of the code follows the indicator group 66666 and reports the bottom depth and surface current. These groups are optional but should be reported by surface ships whenever the data can be measured. If both depth and current are not measured, then the entire section is not reported. If, however, either one of the elements is measured, all three groups beginning with the 66666 indicator should be included in the report, and missing data should be reported with slants. Do not report charted depths or currents. *Charted depths* and *charted currents* are those depths and currents reported on hydrographic or navigation charts.

The water depth measured by a fathometer is reported in group 1Z<sub>d</sub>Z<sub>d</sub>Z<sub>d</sub>Z<sub>d</sub> to the nearest whole meter (or foot if the 9 indicator is included in the time group). This group is omitted when group 00000 is included in section 2.

The measured or calculated surface current set and drift are reported in group k<sub>5</sub>D<sub>c</sub>D<sub>c</sub>V<sub>c</sub>V<sub>c</sub>. The k<sub>5</sub> is an indicator for the method used to determine the current (WMO Code 2266). This is normally reported as a 3, meaning the current is determined from navigational location “fixes” 3 to 6 hours apart, or a 4 if the fixes are 6 to 12 hours apart. Set is the direction the surface current is moving toward, and is reported in D<sub>c</sub>D<sub>c</sub> in hundreds and tens of degrees True. *Drift* is the speed of the current, which is reported in V<sub>c</sub>V<sub>c</sub>, in units and tenths of a knot. The measured water depth and the calculated current may be obtained from the Quartermaster of the Watch (QMOW) on the bridge or the Combat Information Center (CIC).

The 66666 indicator group, bottom depth group, and the surface current group are entered on the log sheet in section III, following the depth and temperature information. See figure 2-11.

## STATION IDENTIFIER

The last section of the report is the station identifier. All ships report only their International Radio Call Sign (IRCS). Aircraft report their squadron designator or the abbreviation “ACFT.” Ocean station platforms and certain buoys report their assigned block and station number following a 99999 identifier group.



The example sounding shown in figure 2-10, and entered in the bathythermograph log in figure 2-11, would be received in message format as follows:

```
JJYY 19057 1204 /72413 08357 30907 40275 88888 00102
00272 21271 38271 60230 81209 90185 93159 99301 01138
14175 34154 99902 20124 62112 79112 99903 76090 92090
99904 19088 00000 66666 31009 NSHP
```

### REVIEW QUESTIONS

- Q20. What information is encoded in section I of the bathythermograph log (CNMOC 3167/2)?
- Q21. When the last digit in the GGgg( ) group is a 9, what is being indicated?
- Q22. What is the code group 4s<sub>n</sub>TTT used to report?
- Q23. How should the group I<sub>X</sub>I<sub>X</sub>I<sub>X</sub>X<sub>R</sub>X<sub>R</sub> be encoded when a Sippican AN/BQH-7/MK-8 recorder is being used along with a Sippican T-5 XBT probe?
- Q24. How should a depth/temperature pair of 420 meters/03.4°C be encoded?
- Q25. How should a depth/temperature pair of 1,312 feet/42.6°F be encoded?
- Q26. What does the group 00000 99903 64102 indicate?
- Q27. To what does the "set" of an ocean current refer?

### BATHYTHERMOGRAPH RECORDS AND REPORTS

---

**LEARNING OBJECTIVE:** Identify what records are required to be forwarded to record collection centers.

---

All successful bathythermograph observations should be encoded and transmitted, regardless of classification. Bathythermograph observations are transmitted to one of two *Collective Address Designators (CADs)*—*OCEANO WEST* or *OCEANO EAST*, as specified in NAVMETOCCOMINST 3140.1, *United States Navy Meteorological and Oceanographic Support System Manual*. All transmitted observations to either of the CADs are automatically entered in both the current information and the historical information data bases. The information then becomes available for acoustic data predictions for all fleet units through the

Fleet Numerical Meteorology and Oceanography Center's data networks.

The only records required to be saved indefinitely are the originals of the completed CNMOC 3167/2 bathythermograph log sheets. Each observation must be properly identified by completing the data block preprinted on each section of the chart. As directed by NAVMETOCCOMINST 3140.1, unclassified original bathythermograph log sheets are forwarded to the National Oceanographic Data Center, NOAA/NESDIS E/OC12, 13 15 E West Highway, Silver Spring, Maryland, 20910-3282, by the fifth day of the following month. Original classified log sheets are forwarded to the Naval Oceanographic Office, 1002 Balch Boulevard, (ATTN Code N34D), Stennis Space Center, Mississippi 39522-5001, by the fifth day of the following month. A meteorological records transmittal form should accompany the log sheets in lieu of a cover letter. **NEVER** delete geographical positions to make any observation unclassified, as observations without position data are useless. Instructions for the proper packaging and handling of classified log sheets are discussed in OPNAVINST 5510.1, *Department of the Navy Information and Personnel Security Program Regulation*.

SECNAVINST 5212.5, *Navy and Marine Corps Records Disposition Manual*, provides guidance for the retention of temporary records. Temporary bathythermograph records, such as the used recorder charts removed from the "take-up" roll and any duplicate copies of the log sheets, are retained on board until no longer needed (usually no more than 6 months).

### REVIEW QUESTIONS

- Q28. What manual outlines procedures for the transmission of bathythermograph observation data?
- Q29. Where are classified original bathythermograph log sheets mailed?
- Q30. How long are duplicate copies of bathythermograph log sheets normally retained on board?

### DECODING DRIFTING BUOY REPORTS

---

**LEARNING OBJECTIVE:** Identify the meaning of each element in the drifting buoy reporting code.

---

Many drifting buoys are deployed from ships and aircraft into the Gulf of Mexico and into the Atlantic and Pacific Oceans. Drifting buoys move with the prevailing currents and automatically report observed meteorological and oceanographic elements via satellite. There are several types of drifting buoys, and not all buoys transmit the same package of environmental data. Normally, drifting buoys sample data continuously, but data is reported only when polar-orbiting meteorological satellites pass over the buoy positions. This occurs a minimum of twice a day.

Information observed by drifting buoys is encoded in WMO International Code FM 18-XI BUOY. This code contains some elements similar to the ship Synoptic code and others similar to the Bathythermograph code. The symbolic format of the BUOY code is shown in table 2-3. The report contains 5 sections of data, identified as section 0 through section 4. Section 0 is identification information, and section 1 contains meteorological and other non-marine data. Section 2 contains surface marine data. Section 3 is used to report bathymetric readings, while the last section, section 4, is used to report engineering and quality control data.

Data from drifting buoys is relayed from satellites to designated sites around the world, where the information is checked for validity and then transmitted over environmental networks. In most cases, the data is already received from the buoy in the ZZZY format, and only the data quality indicators must be encoded.

A typical drifting buoy report, which reports weather and ocean temperatures every 10 meters to 150 meters, would appear similar to the following:

```
SSVX06 KARS 231145
ZZYY 93503 23027 11454 712238 095139 11119
00308 10255 29075 30132 40133 52003 22219
00262 10302 33311 88870 20010 31820 20020
31252 20030 31103 20040 31055 20050 31037
20060 31027 20070 31002 20080 31002 20090
30944 20100 30915 20110 30891 20120 30830
20130 30876 20140 30844 20150 30819 66091
20150 18135 444 201// 23027 1000/ 71227
81101 90150;
```

Other than the information in the buoy identification section, all other data is optional; it is reported only when available. Many drifting buoys

**Table 2-3.—Symbolic Format of WMO Code FM 18-XI BUOY**

SECTION 0	ZZYY A <sub>1</sub> b <sub>w</sub> n <sub>b</sub> n <sub>b</sub> n <sub>b</sub> YYMMJ GGg <sub>w</sub> Q <sub>c</sub> L <sub>a</sub> L <sub>a</sub> L <sub>a</sub> L <sub>a</sub> L <sub>a</sub> L <sub>o</sub> L <sub>o</sub> L <sub>o</sub> L <sub>o</sub> L <sub>o</sub> L <sub>o</sub> (6Q <sub>1</sub> Q <sub>t</sub> Q <sub>A</sub> /)
SECTION 1	111Q <sub>d</sub> Q <sub>x</sub> 0ddff 1s <sub>n</sub> TTT 2S <sub>n</sub> T <sub>d</sub> T <sub>d</sub> T <sub>d</sub> or (29UUU) 3P <sub>o</sub> P <sub>o</sub> P <sub>o</sub> P <sub>o</sub> 4PPPP 5appp
SECTION 2	222Q <sub>d</sub> Q <sub>x</sub> 0s <sub>n</sub> T <sub>w</sub> T <sub>w</sub> T <sub>w</sub> 1P <sub>wa</sub> P <sub>wa</sub> H <sub>wa</sub> H <sub>wa</sub> 20P <sub>wa</sub> P <sub>wa</sub> P <sub>wa</sub> 21H <sub>wa</sub> H <sub>wa</sub> H <sub>wa</sub>
SECTION 3	333Q <sub>d1</sub> Q <sub>d2</sub> 8887k <sub>2</sub> 2Z <sub>n</sub> Z <sub>n</sub> Z <sub>n</sub> Z <sub>n</sub> 3T <sub>n</sub> T <sub>n</sub> T <sub>n</sub> T <sub>n</sub> 4S <sub>n</sub> S <sub>n</sub> S <sub>n</sub> S <sub>n</sub> (66k <sub>6</sub> 9k <sub>3</sub> 2Z <sub>n</sub> Z <sub>n</sub> Z <sub>n</sub> Z <sub>n</sub> d <sub>n</sub> d <sub>n</sub> c <sub>n</sub> c <sub>n</sub> )
SECTION 4	444 1Q <sub>r</sub> Q <sub>2</sub> Q <sub>TW</sub> Q <sub>4</sub> 2Q <sub>N</sub> Q <sub>L</sub> Q <sub>A</sub> / Q <sub>c</sub> L <sub>a</sub> L <sub>a</sub> L <sub>a</sub> L <sub>a</sub> L <sub>a</sub> L <sub>o</sub> L <sub>o</sub> L <sub>o</sub> L <sub>o</sub> L <sub>o</sub> L <sub>o</sub> or (YYMMJ GGg <sub>w</sub> / 7V <sub>B</sub> V <sub>B</sub> d <sub>B</sub> d <sub>B</sub> ) 8V <sub>i</sub> V <sub>i</sub> V <sub>i</sub> V <sub>i</sub> 9i <sub>d</sub> Z <sub>d</sub> Z <sub>d</sub> Z <sub>d</sub>

report surface conditions until the battery fails (about 6 to 12 months), but only report subsurface temperatures/currents/depths for the first 3 to 6 months after deployment, the engineering life of the "tails."

### IDENTIFICATION SECTION

All code groups in section 0 must be included in each report with the exception of the last group. All buoy reports, even those grouped within a collective bulletin, begin with the data type identifier "ZZYY."

Group A<sub>1</sub>b<sub>w</sub>n<sub>b</sub>n<sub>b</sub>n<sub>b</sub> is the WMO assigned area, block, and identification number of each individual buoy. The number is assigned before the buoy is deployed, based on the intended deployment location. This number will remain the same throughout the life of the buoy. In our example, the buoy identifier is 93503.

Groups YYMMJ (the day, month, and year) and GGg<sub>w</sub> are nearly identical to the bathy code identification groups, except for the indicator i<sub>w</sub> used as the last digit of the group. This code figure is used to indicate the units of wind speed (1 = meters per second, 4 = knots). In our example, the date and time of the observation are provided by 23027 11454, for the 23d of February, 1997, at 11452. The indicator 4 shows the wind is measured in knots.

The buoy's position is given by the groups Q<sub>c</sub>L<sub>a</sub>L<sub>a</sub>L<sub>a</sub>L<sub>a</sub>L<sub>a</sub> L<sub>o</sub>L<sub>o</sub>L<sub>o</sub>L<sub>o</sub>L<sub>o</sub>L<sub>o</sub>. Notice that these are each 6-digit groups instead of the standard 5-digit groups. As in the bathy code, Q<sub>c</sub> is quadrant of the globe from WMO code table 3333 (refer to Appendix III). However, L<sub>a</sub>L<sub>a</sub>L<sub>a</sub>L<sub>a</sub>L<sub>a</sub>L<sub>a</sub> is the latitude to the nearest thousandth of a degree (3 decimal places). Likewise, L<sub>o</sub>L<sub>o</sub>L<sub>o</sub>L<sub>o</sub>L<sub>o</sub>L<sub>o</sub> is the longitude to the nearest thousandth of a degree. A report may replace the last figure in each group with a slant if the position is only reported to the nearest hundredth of a degree. For example, 712238 095139 would report a position in

quadrant 7 (north of equator, west of prime meridian) as 12.238° North, 095.139° West, whereas 71224/09514/ is the same position reported only to the nearest hundredth of a degree.

The last part of the identification section is the optional group 6Q<sub>1</sub>Q<sub>t</sub>Q<sub>A</sub>/. This group is based on WMO Code Table 3334 and is used as a quality control indicator, with Q<sub>1</sub> and Q<sub>A</sub> used for position and Q<sub>t</sub> for time. This group must be encoded manually. See table 2-4.

## METEOROLOGICAL DATA

Within the meteorological data section, winds, air temperature, dewpoint temperature, and relative humidity may be reported. In addition, pressure data, such as station pressure, sea level pressure, and 3 hour pressure tendency, may also be reported. Each group in section 1 is only reported if the buoy actually measures the information. All groups are identical to the ship Synoptic code (WMO 13-X SHIP), except for the use of the group indicator 0 for the wind data group and the relative humidity group (29UUU).

The meteorological section is identified by the group 111Q<sub>d</sub>Q<sub>x</sub>. The code figure Q<sub>d</sub> is the quality control indicator, and Q<sub>x</sub> indicates the position of any one group in this section that is not good, if applicable. Otherwise, Q<sub>x</sub> is encoded as a 9. In our example, the groups 00308 10255 29075 30132 40133 52003 report winds from 030° true at 08 knots, air temperature 25.5°C, relative humidity of 75%, station pressure of 1013.2 hPa, and sea-level pressure at 1013.3 hPa. The last group is the pressure tendency and amount of change (hPa) during the past 3 hours. Only three codes are used for tendency (2 = pressure increasing, 4 = pressure steady, 7 = pressure decreasing). In our example, the pressure is indicated as rising and up 0.3 hPa.

## SURFACE MARITIME DATA

As with the meteorological data, each section 2 surface maritime data group is only included if the information is measured by the buoy. The indicator 222Q<sub>d</sub>Q<sub>x</sub> will always precede any surface maritime data, but is itself omitted if no groups from section 2 are reported. The group 0s<sub>n</sub>T<sub>w</sub>T<sub>w</sub>T<sub>w</sub> is used to report the sea-surface temperature. The code figure s<sub>n</sub> is the sign of the temperature (0 = positive, 1 = negative). For example, the group 00262 reports sea-surface temperature at 26.2°C.

Some buoys contain a sensor that measures wave action. If the sensor measures wave period to the

nearest second and wave height to the nearest half-meter, code group 1P<sub>wa</sub>P<sub>wa</sub>H<sub>wa</sub>H<sub>wa</sub> is used. In our example, 10302 reports a wave period of 3 seconds, and a wave height as 2 half-meters (3 feet). Other buoys contain more accurate instruments that measure wave period to the nearest tenth of a second and wave height to the nearest tenth meter. These buoys report wave period to the nearest tenth of a second in the group 20P<sub>wa</sub>P<sub>wa</sub>P<sub>wa</sub>, and wave height to the nearest tenth meter in the group 21H<sub>wa</sub>H<sub>wa</sub>H<sub>wa</sub>.

## OCEANOGRAPHIC DATA

Section 3 is used to report readings obtained from sensors on a drifting buoy's tail. Sensors are normally fixed to the tail at set intervals. Most drifting buoys only measure temperature, but more sophisticated buoys may include salinity measuring devices and water current measurement devices at various levels.

The data groups in the first portion of section 3 following the 333Q<sub>d1</sub>Q<sub>d2</sub> 8887k<sub>2</sub> indicator groups are used to report seawater temperature and salinity readings. The Q<sub>d1</sub> and Q<sub>d2</sub> are used to indicate the quality of the temperature/salinity profile and the quality of the current (set and drift) profile, respectively. The indicator k<sub>2</sub> is the method used for the salinity measurement as per WMO Code 2263 (0 = no measurement, 1 = electronic sensor with better than 0.02% accuracy, 2 = electronic sensor with less than 0.02% accuracy, and 3 = sample analysis). As of the late 1990s few buoys carry salinity sensors.

**Table 2-4.—WMO Code Table 3334**

Q <sub>d</sub>	= Quality control indicator
Q <sub>d1</sub>	= Quality control indicator for temperature/salinity.
Q <sub>d2</sub>	= Quality control indicator for current (set/drift) profile.
Q <sub>1</sub> Q <sub>A</sub>	= Quality control indicator for position.
Q <sub>t</sub>	= Quality control indicator for time.
Code	Figure
	0 = Data not checked
	1 = Data good
	2 = Data inconsistent
	3 = Data doubtful
	4 = Data wrong
	5 = Data value has been changed

The three groups,  $2z_n z_n z_n z_n$ ,  $3T_n T_n T_n T_n$ , and  $4S_n S_n S_n S_n$ , are repeated for each level of measured data. The  $z_n z_n z_n z_n$  reports each depth in whole meters. For example, 20001 reports a depth of 1 meter below surface, and 20150 reports a depth of 150 meters. Temperatures are reported by  $T_n T_n T_n T_n$  to the nearest hundredth degree Celsius, with 5,000 added to the temperature to indicate values below zero degree Celsius. In our example, 20010 31820 reports a temperature of 18.20°C at 10 meters. A report 35120 would indicate a temperature of -1.20°C. The salinity group  $4s_n s_n s_n s_n$  is only included if salinity measurements have been made. This group reports salinity to the nearest hundredth of a part-per-thousand. A report of 43472, for example, is 34.72%.

In the second portion of section 3, under-sea current set and drift is reported. This report, if included, will be preceded by an indicator group  $66k_6 9k_3$ . Indicator  $k_6$  refers to WMO Code Table 2267, the method used to correct the current measurement for the buoy's movement. Indicator  $k_3$  is the indicator for the duration and time of the data sampling for the current measurement from WMO Code Table 2264. Neither are significant for decoding purposes. For each level where the current is reported, the depth is reported by using a  $2z_n z_n z_n z_n$  group, and then the direction and speed of the current are reported in the group  $d_n d_n c_n c_n c_n$ . The  $d_n d_n$  reports the set of the current (direction towards) in tens of degrees True, while  $c_n c_n c_n$  reports the drift of the current in centimeters per second (hundredth of a meter-per-second). For rough approximations, doubling the meters-per-second value yields a value in knots. For example, 20150 18135 reports the current at 150 meters moving toward the south (set = 180° True) at 2.7 knots (drift = 135 centimeters or 1.35 meters-per-second).

## QUALITY CONTROL DATA

Section 4 of the report, beginning with the indicator 444, reports quality control information. Actual movement of the buoy may be reported in this section and may be interpreted as a surface current speed and direction. Many values after the 444 indicator may be ignored for normal data applications. However, personnel assigned data monitor duties at activities where the reports are received, must encode these values to signify if the buoy is functioning properly. Normally, if a buoy sensor is operating within acceptable limits, the information in this section will not appear in the transmitted report. Thus, the absence of

this section, with the exception of the  $8V_i V_i V_i V_i$  and the  $9i_d Z_d Z_d Z_d$  groups, indicates satisfactory operation Of the buoy.

In order of appearance in the code, QP is the quality of the pressure report;  $Q_2$  is the quality of the buoys "house-keeping"; QTW is the quality of the sea-surface temperature report, and 44 is the quality of the air-temperature report; QN is the quality of the satellite transmission; and QL and QA are the quality of the reported location. When the quality of the reported buoy position in section 0 is doubtful, a second latitude/longitude group may be repeated in this section.

The actual movement of the buoy may also be reported in this section as an aid in determining buoy location. The movement of the buoy may be used as an approximate surface water current, especially if a drogue anchor is affixed to the buoy. The buoy movement group,  $7VBVBdBdB$ , begins with the date/time of the last known position using a YMMJ GGgg/ group. The speed of movement, VBVB, is given in centimeters per second (multiplied by .10). The direction of movement, dBdB, is given in tens of degrees. In our example, 71227 would indicate that the buoy has moved at 2.4 knots (120 centimeters or 1.20 meters-per-second) toward the west (270° True).

The  $8V_i V_i V_i V_i$  group contains an engineering code. Ignore this group.

The  $9i_d Z_d Z_d Z_d$  group contains buoy cable (drogue) data. The code figure  $i_d$  indicates the type of drogue used. The last 3 digits in the group,  $Z_d Z_d Z_d$ , is the length of the drogue in meters.

Surface meteorological observations from drifting buoys are normally automatically processed and plotted on computer-produced surface charts. The bathymetric reports are not routinely plotted. The positions of the buoys should be monitored and the bathymetric data entered into TESS or MOSS when buoys are near your operating area. These reports will expand your USW area prediction capabilities.

## REVIEW QUESTIONS

- Q31. What information is contained in section 2 of the drifting buoy code?*
- Q32. What is the data identifier for a drifting buoy report?*

- Q33. *When a drifting buoy is reporting good temperature/salinity data, but doubtful ocean current data, what is encoded at the beginning of section 3 in the drifting buoy report?*
- Q34. *What would the groups 20050 32234 43547 in section 3 of a drifting buoy message indicate?*
- Q35. *How would an ocean current data group of 20020 15097 be interpreted in a drifting buoy message?*

## SUMMARY

In this chapter, we have reviewed the three basic properties that affect sound velocity in seawater. We discussed the various uses of bathythermograph data, and also discussed the two types of bathythermograph recording systems used by fleet units. The procedures used to evaluate raw BT data and to encode and record the data were also covered. Finally, we explained how to decode BUOY reported bathymetric data.

# ANSWERS TO REVIEW QUESTIONS

- A1. *Salinity.*
- A2. *Temperature.*
- A3. *Pressure.*
- A4. *US W support.*
- A5. *Analyze fronts, eddies, and other oceanographic thermal features, provide input into oceanographic forecasts, build climatological data bases, and assist in research and development of oceanographic and acoustic models.*
- A6. *At the synoptic hours (00Z, 06Z, 12Z, 18Z) and when entering areas of differing ocean thermal structure such as in the vicinity affronts, eddies, major river outflow areas, etc.*
- A7. *1,500 feet.*
- A8. *The RO-326B or RO-326C/SSQ-56 recorder, the MX-8577/SSQ-61 launcher, and the OC-14/SSQ-56 XBT probe.*
- A9. *Expendable bathythermograph.*
- A10. *The ready-for-launch mode calibration temperature and the alignment of the stylus on the surface depth line.*
- A11. *A built-in tape recorder.*
- A12. *Connection to the Navy Tactical Data System (NTDS).*
- A13. *Sound velocity trace.*
- A14. *Direct measurement of sound velocity.*
- A15. *Leak from probe wire to salt water.*
- A16. *Sharp variations in ocean thermal structure caused by fronts, eddies, etc.*
- A17. *Positive gradient.*
- A18. *Surface. mixed layer, tops and bases of isothermal layers, significant inflection points, and the deepest part of the trace.*
- A19. *20.*
- A20. *Reference/identification information.*
- A21. *All the following data is reported in English units.*

- A22. *The outside air temperature.*
- A23. *01104.*
- A24. *99904 20034.*
- A25. *9990131426.*
- A26. *That the bottom depth is 364 meters, at 10.2°C.*
- A27. *The direction the ocean current is moving towards.*
- A28. *NAVMETOCOMINST 3140.1, United States Navy Meteorological and Oceanographic Support System Manual.*
- A29. *Naval Oceanographic Office, Stennis Space Center, Mississippi.*
- A30. *Six months.*
- A31. *Surface marine data.*
- A32. *ZZYY.*
- A33. *33313.*
- A34. *At 50 meters, the seawater temperature is 22.34°C, and the salinity is 35.47 parts-per-thousand.*
- A35. *At 20 meters, the set of the current is 150° at 09.7 centimeters per second.*





## CHAPTER 3

# AVIATION WEATHER CODES

### INTRODUCTION

In this chapter we will discuss two meteorological codes routinely encountered by Aerographers, particularly at shore-based commands. The first code we will discuss is the Terminal Aerodrome Forecast (TAF) code. You must be able to recognize the various elements that make up this code because you may be tasked with preparing a TAF for dissemination. The second code we will discuss is the Pilot Weather Report (PIREP) code. This code details in-flight weather conditions reported directly from aircraft via pilot-to-metro service (PMSV) radio. The meteorological information received must then be encoded for electronic transmission to data collection centers.

### TERMINAL AERODROME FORECAST (TAF) CODE

*LEARNING OBJECTIVES:* Identify the primary reference publication concerning the Terminal Aerodrome Forecast (TAF) code. Identify when TAFs should be transmitted. Describe the format, elements, and abbreviations used in the TAF code. Explain the requirements for amending TAFs.

The Terminal Aerodrome Forecast (TAF) code provides information about the expected weather conditions that will occur at your airfield or station control zone. Only certified forecasters are authorized to write TAFs. However, as the observer, you will often be tasked to prepare the latest TAF for transmission locally and over longline. The TAF code is presented here so you will be able to recognize the various elements of the code and be able to spot encoding errors if they occur.

### TAF FORMAT

The WMO Meteorological code FM51-X is used internationally as the standard TAF format. NAVMETOCCOMINST 3143.1 is the governing instruction for using the TAF code for all U.S. Navy and Marine Corps weather activities. It is identical to the WMO TAF code with only minor differences.

TAFs are transmitted at 6-hour intervals at 0300, 0900, 1500, and 2100 UTC, and have valid periods of 24 hours. The complete TAF format is shown in table 3-1 and is explained in the following sections.

The symbolic indicator **CCCC** is the ICAO location identifier followed by "TAF," and then the valid forecast period day and time (**Y<sub>1</sub>Y<sub>1</sub>G<sub>1</sub>G<sub>1</sub>G<sub>2</sub>G<sub>2</sub>**). Example: KNGU TAF 230909 is the aerodrome forecast for Norfolk, Virginia, valid for 24 hours from the 23rd 0900 UTC to the 24th 0900 UTC.

Table 3-1.—TAF Code Format and Sample

**CCCC TAF (AMD or COR or RTD) Y<sub>1</sub>Y<sub>1</sub>G<sub>1</sub>G<sub>1</sub>G<sub>2</sub>G<sub>2</sub> dddffG<sub>f</sub><sub>f</sub>m<sub>f</sub>m<sub>f</sub>KT VVVV**  
**w'w' N<sub>s</sub>N<sub>s</sub>N<sub>s</sub>h<sub>s</sub>h<sub>s</sub>h<sub>s</sub> or SKC or VVh<sub>s</sub>h<sub>s</sub>h<sub>s</sub> (WSH<sub>ws</sub>h<sub>ws</sub>h<sub>ws</sub>/dddffKT or**  
**WSCONDS) (6L<sub>c</sub>h<sub>i</sub>h<sub>i</sub>h<sub>i</sub>t<sub>L</sub>) (5Bh<sub>b</sub>h<sub>b</sub>h<sub>b</sub>t<sub>L</sub>) QNHP<sub>1</sub>P<sub>1</sub>P<sub>1</sub>INS (Remarks)**  
**(TTTTT GGG<sub>e</sub>G<sub>e</sub>/TTGGGG) (TT<sub>F</sub>T<sub>F</sub>/G<sub>F</sub>G<sub>F</sub>Z) AMD or COR GGGG)**

**KNGU TAF 210909 23012KT 4800 -SN BKN005 OVC012 620107**

**QNH3002INS**

**TEMPO 0914 0800 +SNRA -BLSN VV002**

**BECMG 0506 33018KT 510804 QNH3015INS T01/15Z**

All amended forecasts will use the time the forecast is amended as the beginning time, and the standard time of the forecast period as the ending time. For example, if the 281515 TAF is amended at 281700, it would be encoded 281715. The abbreviation "AMD" is used to indicate an amended TAF. The abbreviation "RTD" indicates a routine delay, and "COR" indicates a corrected TAF. Specific meteorological elements of the TAF code are as follows:

1. Element **ddfffG<sub>m</sub>f<sub>m</sub>KT** is the surface wind direction to the nearest 10 degrees, and the wind speed in knots. Gusts are also included when applicable. The contraction "VRB" may be used for direction when the average wind speed is 6 knots or less. Calm winds are encoded as "00000KT."

2. Element **VVVV** is the prevailing visibility in meters, rounded down to the nearest reportable value. Reportable values are identical with those in NAVMETOCCOMINST 3141.2, *Surface METAR Observations User's Manual*. Weather and/or obstructions to vision must be included whenever the prevailing visibility is forecast to be 9000 meters (6 SM) or less.

3. Element **w'w'** includes the forecast weather and obstructions to vision using the standard abbreviations as outlined in NAVMETOCCOMINST 3141.2 and NAVMETOCCOMINST 3144.1, *United States Navy Manual for Ship's Surface Weather Observations*.

4. Element **N<sub>s</sub>N<sub>s</sub>N<sub>s</sub>h<sub>s</sub>h<sub>s</sub>h<sub>s</sub>** is the sky cover group using standard abbreviations (i.e., SCT, FEW, etc.). Heights are reported in hundreds of feet AGL in accordance with NAVMETOCCOMINST 3141.2 and NAVMETOCCOMINST 3144.1. This group is reported as often as necessary to indicate all forecast sky cover layers up to the forecast overcast (8/8) layer. The summation principle used in the METAR code also applies to the TAF code. Groups are reported in ascending order. Clear skies are reported as "SKC." Types of clouds are not encoded with the exception of cumulonimbus clouds, which are always reported as a separate group using the abbreviation CB. For example, 3/8 cumulonimbus clouds at 2,500 feet would be encoded as SCT025CB.

Partial obscurations are considered as the first layer in the sky cover group (i.e., fog forecast to cover 2/8 of the station would be encoded as SCT000). Total obscurations are reported using the VVh<sub>s</sub>h<sub>s</sub>h<sub>s</sub> group as per NAVMETOCCOMINST 3141.2 and NAVMETOCCOMINST 3144.1.

5. The element **WSh<sub>ws</sub>h<sub>ws</sub>h<sub>ws</sub>/ddfffKT** or **WSCONDS** is the non-convective, low-level wind shear (LLWS) group. This group is used only to forecast wind shear not associated with convective activity from the surface to 2,000 feet. The abbreviation WS is the LLWS indicator, and h<sub>ws</sub>h<sub>ws</sub>h<sub>ws</sub> is the forecast height of the wind shear in hundreds of feet AGL. The contraction WSCONDS indicates that wind shear conditions are present but complete information cannot be reliably forecast.

6. The element **6I<sub>c</sub>h<sub>i</sub>h<sub>i</sub>h<sub>i</sub>t<sub>L</sub>** is the icing group (not associated with thunderstorms). The number 6 is the icing indicator and I<sub>c</sub> represents the type of icing, as encoded from table 3-2. The h<sub>i</sub>h<sub>i</sub>h<sub>i</sub> is the icing layer base in hundreds of feet AGL. The t<sub>L</sub> represents the thickness of the icing layer in thousands of feet, as encoded from table 3-3. Example: 650203 indicates moderate icing in cloud from 2,000 to 5,000 feet.

7. Element **5Bh<sub>b</sub>h<sub>b</sub>h<sub>b</sub>t<sub>L</sub>** is the turbulence group (not associated with thunderstorms). The number 5 is the turbulence indicator and the letter "B" is the turbulence type and intensity encoded from table 3-4. Extreme turbulence is encoded with an "X." The h<sub>b</sub>h<sub>b</sub>h<sub>b</sub> is the forecast height of the turbulence in hundreds of feet AGL. The t<sub>L</sub> is the thickness of the turbulence layer in thousands of feet AGL, as encoded from table 3-3. Example: 561205 indicates occasional severe turbulence in clear air from 12,000 to 17,000 feet.

**Table 3-2.—Icing Type (I<sub>c</sub>)**

I <sub>c</sub> = Type of forecast ice accretion on external parts of aircraft	
Code	Figure
0	No Icing
1	Light Icing
2	Light Icing in Cloud
3	Light Icing in Precipitation
4	Moderate Icing
5	Moderate Icing in Cloud
6	Moderate Icing in Precipitation
7	Severe Icing
8	Severe Icing in Cloud
9	Severe Icing in Precipitation

**Table 3-3.—Thickness of Icing and Turbulence Layers (t<sub>L</sub>)**

Code Figure	Thickness
1	1,000 feet
2	2,000 feet
3	3,000 feet
4	4,000 feet
5	5,000 feet
6	6,000 feet
7	7,000 feet
8	8,000 feet
9	9,000 feet

**Table 3-4.—Turbulence Type and Intensity (B)**

B = Turbulence	
Code	Figure
0	None
1	Light Turbulence
2	Moderate Turbulence in clear air, occasional
3	Moderate Turbulence in clear air, frequent
4	Moderate Turbulence in cloud, occasional
5	Moderate Turbulence in cloud, frequent
6	Severe Turbulence in clear air, occasional
7	Severe Turbulence in clear air, frequent
8	Severe Turbulence in cloud, occasional
9	Severe Turbulence in cloud, frequent
X	Extreme Turbulence

8. Element **QNHP<sub>1</sub>P<sub>1</sub>P<sub>1</sub>P<sub>1</sub>INS** is the lowest altimeter setting in inches expected during the forecast period.

9. The elements **TTTTT GGG<sub>e</sub>G<sub>e</sub>** or **TTGGGG** are change groups used to indicate changes in some or all of the elements forecast to occur at some intermediate time during the 24-hour forecast period. Several change groups may be used to properly identify forecasted conditions as explained below.

The contraction “FMGGGG” indicates the beginning of a change period in the forecast. All forecast conditions preceding this group are superseded by the conditions forecast in this group. For example, if the TAF period is 1515 and a change is forecast at 1930 UTC, the entry "FM1930" is encoded. The elements entered following this contraction are in effect from 1930 UTC until the end of the forecast period, 1500 UTC.

The contraction "BECMG" is used to indicate a change to forecast conditions ‘expected to occur at regular or irregular periods at an unspecified time within the time period identified. The duration of the change should not normally exceed 4 hours.

The contraction “TEMPO” is used to indicate frequent or infrequent temporary fluctuations to the forecasted meteorological conditions that are expected to last less than 1 hour in each instance, and an aggregate total of less than half the time of the forecast period indicated.

10. Element **TT<sub>F</sub>T<sub>F</sub>/G<sub>F</sub>G<sub>F</sub>Z** is the temperature group. This is an optional group. The letter "T" is the temperature indicator and T<sub>F</sub>T<sub>F</sub> is the forecast maximum or minimum temperature in whole degrees Celsius, depending on the time of day. The G<sub>F</sub>G<sub>F</sub> is the time at which the maximum or minimum temperature is expected to occur.

### TAF AMENDMENTS

Occasionally a TAF will need to be amended. Established amendment criteria are based on ceiling and visibility requirements outlined in OPNAVINST 3710.7, *NATOPS General Flight and Operating Instructions*, and other safety of flight considerations. Part of your job as an observer is to keep the forecaster aware of any changes to the meteorological situation

that may require an amended TAF. Table 3-5 is a summary of minimum amendment criteria. More stringent amendment criteria may be established locally. The actual time that the amendment is completed for transmission is the last element encoded. For example, an amendment completed at 2130 UTC would have as the last element "AMD 2130."

Not all, but most aviation weather offices are equipped with a PMSV voice radio. PMSV radio is used to pass updated weather observations and forecasts to aircraft in flight and to receive pilot-reported, flight-level, weather observations or pilot reports (PIREPs). The duty observer is normally assigned the responsibility to transmit and receive traffic over the PMSV radio. In the next section, we will discuss the PIREP code.

## REVIEW QUESTIONS

- Q1. What instruction governs the use of the Terminal Aerodrome Forecast (TAF) code for Navy and Marine Corps activities?
- Q2. What are the standard synoptic times for the transmission of TAFs and what is the valid forecast period?
- Q3. What cloud genus is always reported as a separate group for element  $N_s N_s N_s h_s h_s h_s$  of the TAF code?
- Q4. When is the abbreviation "WSCONDS" used in the TAF code?
- Q5. How should light icing from 6,000 to 10,000 feet be encoded in a TAF?

Table 3-5.—Minimum Amendment Criteria

Minimum Amendment Criteria									
Ceilings and Visibilities	<ul style="list-style-type: none"> <li>● Whenever ceilings and/or visibilities are observed or are later forecast to increase to, equal or exceed, or decrease to less than any of the following: <table style="margin-left: auto; margin-right: auto; border: none;"> <thead> <tr> <th style="text-align: center;"><u>Ceiling</u></th> <th style="text-align: center;"><u>Visibility</u></th> </tr> </thead> <tbody> <tr> <td style="text-align: center;">3,000 ft</td> <td style="text-align: center;">4,800 meters</td> </tr> <tr> <td style="text-align: center;">1,000 ft</td> <td style="text-align: center;">1,600 meters</td> </tr> <tr> <td style="text-align: center;">200 ft</td> <td style="text-align: center;">800 meters</td> </tr> </tbody> </table> </li> </ul>	<u>Ceiling</u>	<u>Visibility</u>	3,000 ft	4,800 meters	1,000 ft	1,600 meters	200 ft	800 meters
<u>Ceiling</u>	<u>Visibility</u>								
3,000 ft	4,800 meters								
1,000 ft	1,600 meters								
200 ft	800 meters								
Surface Winds	<ul style="list-style-type: none"> <li>● Wind speed change of 10 knots or more.</li> <li>● Directional change of 30° or more when mean wind or gusts are in excess of 15 knots.</li> <li>● Winds speed or directional change resulting in change of active runway.</li> </ul>								
Thunderstorm or Tornadoic Activity	<ul style="list-style-type: none"> <li>● Thunderstorm or tornadoic activity was not forecast to occur, but later occurs or is expected to occur.</li> <li>● Thunderstorm or tornadoic activity was forecast, but later is not expected.</li> </ul>								
Precipitation	<ul style="list-style-type: none"> <li>● Precipitation that will affect safety of flight, including runway braking action, is occurring or is forecast to occur, or if forecast, is no longer expected.</li> </ul>								
Non-Convective, Low-Level Wind Shear	<ul style="list-style-type: none"> <li>● Low-Level Wind Shear is occurring or forecast to occur, or if forecast, is no longer expected.</li> </ul>								
QNH	<ul style="list-style-type: none"> <li>● Whenever the observed altimeter falls below, or is expected to fall below the original forecast.</li> </ul>								

- Q6. What does the element 541003 indicate in a TAF?
- Q7. What does the element QNH2991INS indicate in a TAF?
- Q8. When is the abbreviation "FM" used in a TAF?
- Q9. What change group should be used to indicate a forecast period of rain showers lasting approximately 30 to 45 minutes?
- Q10. Relative to surface winds, what are the minimum requirements for amending a TAF?

## PILOT WEATHER REPORTS

---

**LEARNING OBJECTIVES:** Identify the primary reference publication concerning pilot weather reports (PIREPs). Identify when PIREPs should be submitted by pilots, and when these reports should be forwarded to data collection centers. Describe the format, elements, and abbreviations used in PIREPs.

---

Pilot-reported weather conditions are used throughout the world to supplement weather conditions observed from the ground. There are several types of reports that are routinely used and should be identified by Navy and Marine Corps observers. As we mentioned in chapter 1, "Upper-air Observations," the AMDAR code (WMO International code 42-XI) is automatically encoded by equipment installed aboard civilian aircraft. These reports contain pressure, temperature, and turbulence reports. The CODAR code (WMO International code FM 41-IV) is manually encoded and transmitted by civilian aircraft pilots to report flight-level temperatures and winds, mostly over ocean areas.

Many countries throughout the world use national code forms to transmit pilot-reported weather conditions. Most of these code forms are not readily disseminated outside the originating country. Within the United States, its territories, and in some countries where U.S. military forces are stationed, a national code form, the PIREP code, is used to encode and transmit significant weather observed by pilots. NAVMETOCCOMINST 3142.1, *Procedures Governing Pilot Weather Reports (PIREPS)*, outlines procedures for reporting and encoding PIREPS for all U.S. Navy and Marine Corps weather activities.

## PILOT-REPORTED CRITERIA

In the United States, pilots are encouraged to provide a PIREP whenever they encounter any weather during takeoff, climb to flight level, at flight level, during descent, or on landing that is of meteorological significance to other aircraft or to surface activities. Significant weather is defined as any weather that may affect the flight performance of an aircraft, or is capable of causing injury or damage to personnel or property on the ground. Such phenomena as low-level wind shear (LLWS), thunderstorms and associated thunderstorm phenomena, icing, and turbulence are all considered significant.

Pilots are also encouraged to make negative reports for conditions that are forecast but not observed in flight. For instance, if clear-air turbulence (CAT) or thunderstorms are briefed as occurring in the area and no evidence of the phenomena is observed by a pilot, the pilot should report these conditions as "not occurring."

In particular situations, a briefer may request that a pilot provide information that is not observable from the ground. This may include information on the height of cloud tops, the actual height of cloud bases, the presence of clear levels in a deep layer of assumed solid cloud, or the presence or absence of en route weather over data sparse areas. Pilots are also encouraged to report actual measurements of flight level winds and temperatures.

To provide a means to evaluate the report, pilots are asked to provide certain information with all reports. The minimum information required with any PIREP is (a) the location of the aircraft with respect to a navigational aid, (b) the flight level of the aircraft, (c) the type of aircraft, and (d) at least one meteorological element observed, with time of occurrence. The observer evaluates the reported conditions, and then prepares the report for transmission.

## RECORDING AND ENCODING INFORMATION

As previously mentioned, the recording and reporting of PIREP information for Navy and Marine Corps activities is covered in detail in NAVMETOCCOMINST 3142.1. All military weather observers, particularly those stationed within the United States, must be thoroughly familiar with this instruction. In addition, forecasters should monitor all PIREPS received, paying particular attention to the those PIREPS reporting hazardous flight conditions. PIREP information can also be used to supplement in-flight weather briefings as appropriate.

There is a wide variety of conditions that a pilot may report. All reported information is entered as it is received on NMOC 3140/10, the PIREP report form (fig. 3-1).

The upper portion of the form is used to record the reported information. The lower portion of the form is used to encode the PIREP for transmission.

Abbreviated plain language is used in the encoded portion of the message to enter each reported element. The abbreviations permitted for use are found in FAA Order 7340.1, *Contractions*.

The contractions most frequently used are as follows:

ABV	above	MOD	moderate (icing, turbulence, or precipitation)
BKN	broken (sky coverage)	MOV	moving
BLO	below	MX	mixed
CAT	clear air turbulence	N	north
CHOP	chop (turbulence)	NE	northeast
CLR	clear (icing)	NEG	negative (not present)
CTC	contact	NMRS	numerous (area coverage)
DURGC	during climb	NW	northwest
DURGD	during descent	OCNL	occasional (occurrence)
E	east	OVC	overcast (sky coverage)
EXTRM	extreme	RIME	rime icing
FEW	few (area/sky coverage)	RY	runway
FRQ	frequent	S	south
FV	flight level visibility	SCT	scattered (sky coverage)
GND	ground	SE	southeast
HVY	heavy (precipitation)	SEV	severe (icing or turbulence)
ISOL	isolated (area coverage)	SFC	surface
LGT	light (turbulence, icing, or precipitation)	SKC	sky clear
LLWS	low-level wind shear	SW	southwest
LN	line (area coverage)	TRACE	trace (icing)
LTGCA	cloud to air lightning	TS	thunderstorm
LTGCC	cloud to cloud lightning	UNKN	unknown
LTGCG	cloud to ground lightning	W	west
LTGIC	in cloud lightning	–	to or through (layer)

<b>PIREP</b>			1 . DATE/TIME PIREP RECEIVED (Z)		
2 . LOCATION AND/OR EXTENT OF PHENOMENA			3 . TIME OBSERVED (Z)		
4 . PHENOMENA AND ALTITUDE					
5 . AIRCRAFT TYPE					
Legend → = SPACE                      * CAT/CHOP OR BLANK                      ** ONLY IF DIFFERENT FROM FL					
(U) UA→ /OV		/TM →		/FL → /TP →	
MSG TYPE	LOCATION OF PHENOMENA - 4 letter ID, RADIAL/DISTANCE	TIME (Z)	FLT LVL	TYPE ACFT	
/SK→		/WX→		/TA→	
SKY CONDITIONS - AMOUNT/BASE/TOPS		FLIGHT VISIBILITY AND/OR WEATHER CONDITIONS		TEMPERATURE °C	
/WV→		/TB→		/IC→	
WIND (DIR/SPD)	TURBULANCE INTENSITY TYPE* ALTITUDE**	ICING INTENSITY TYPE ALTITUDE**			
/RM →					
REMARKS PLAIN TEXT WITH APPROPRIATE ABBREVIATIONS (MOST HAZARDOUS ELEMENT FIRST)					
6. EVALUATION FOR DISSEMINATION (MARK "A" OR "B", AND "C" AS APPROPRIATE)				INITIALS	
A . LOCAL DISSEMINATION	B . LONGLINE DISSEMINATION	C . FOR USE IN SURFACE OBSERVATION		FCSTR	OBSRV
<input type="checkbox"/>	<input type="checkbox"/>	<input type="checkbox"/>			

N M O C 3 1 4 0 / 1 0 ( R E V . 7 / 9 6 )                      S / N 0 1 0 8 - L F - 1 1 3 - 4 7 0 0                      AGM2F301

Figure 3-1.—NMOC 3140/10, the PIREP report form.

Locations are referenced only with respect to electronic navigation aid stations using VOR (very-high-frequency omnidirectional range), TACAN (tactical air navigation), or VORTAC (a combined facility). These locations are identified using the three-letter national identifier, as listed in FAA Order 7350.6, *Location Identifiers*. The DOD Flight Information Publication (Enroute) and IFR Supplement lists all VHF, TACAN, and VORTAC facilities, along with the facility's four-letter International Civil Aviation Organization (ICAO) identifier. The last three letters of the ICAO identifier are the national identifier. For example: NAS Norfolk (Chambers Field) has a national identifier NGU while the ICAO identifier is KNGU. The K is the Country code for the continental United States.

The Text Element Indicators (TEIs), a slash followed by a two-letter abbreviation, are used in the code to indicate which element is being reported (refer to fig. 3-1). TEIs are included in the coded PIREP before each reported element, but is omitted if that

element is not being reported. The type of information that follows each TEI is indicated on the PIREP code form below the space provided. An arrow after the TEI means a space must follow the TEI before the abbreviated information. Table 3-6 gives the different TEIs used, the meaning of each, and examples of entries for each TEI.

The PIREP code is fairly flexible concerning entries for each element. As long as standard abbreviations are used, nearly all significant information may be reported. Reports of elements that are difficult to encode after a TEI, such as low-level wind shear, are entered after the last TEI - "/RM" for remarks. The reported occurrence of a tornado, funnel cloud, or waterspout may be abbreviated in the "/WX" weather TEI. However, when any of these three elements occur, they must be spelled out in the "/RM" remarks TEI, along with any supplemental information, such as the approximate location, direction, and speed of movement.

Table 3-6.—PIREP Coded Text Element Indicators and Examples of Entries

TEI	MEANING	EXAMPLE	DECODED MESSAGE
/OV	OVer location	/OV KNGU /OV KNGU 120035	directly over KNGU 120° (magnetic) from KNGU at 35 nmi
/TM	TiMe (UTC)	/TM 1135	phenomena occurred at 1135Z
/FL	Flight Level	/FL 120	aircraft flying at 12,000 feet (MSL)
/TP	aircraft TyPe	/TP F16 /TP C5	reported by an F-16 reported by a C-5
/SK	SKy cover	/SK SCT030-060 /SK OVC065-UNKN	scattered cloud layer bases 3,000 ft, tops 6,000 ft (MSL) in overcast layer, bases 6,500 ft (MSL), tops unknown
/WX	Weather	/WX FV02SM TSRA GR /WX FV99SM	FL visibility 02 statute miles, in thunderstorm with rain and hail FL visibility unrestricted
/TA	Temperature (outside Air)	/TA 01 /TA M10	outside air temperature 1°C outside air temperature -10°C
/WV	Wind dir/spd	/WV 09060KT	wind from 090°(true) at 60 knots
/TB	TurBulence	/TB NEG BLO 080 /TB MOD 120-180 /TB MOD-SEV CAT	forecast turbulence not present below 8,000 ft turbulence moderate 12,000 to 18,000 ft clear air turbulence moderate to severe (at flight level)
/IC	ICing	/IC MOD RIME 035-075	moderate rime icing 3,500 to 7,500 ft
/RM	ReMark	/RM WATERSPOUT MOV ENE	waterspout sighted, moving east-northeast

Weather elements reported after the "/WX" TEI should conform to the METAR Surface Meteorological Observation code. No more than three weather groups should be reported in a single PIREP. Consult the latest NAVMETOCCOMINST 3142.1 for detailed descriptions and permissible entries for each TEI.

### TRANSMITTING PIREPS

Nearly all PIREPs received should be encoded and disseminated both locally and via electronic circuits to central data collection centers. The only PIREPs not disseminated are as follows:

- When two or more PIREPS are received reporting essentially the same information for the same area, only the most recent is sent out.
- PIREPs are not disseminated locally if essentially the same information has been sent out in the past 30 minutes.
- A PIREP is not disseminated if it reports only sky conditions that have already been reported in a METAR or SPECI observation.

Normally, all PIREPs are prefixed with the message header UA. When sent out in a collective, which is several PIREPs sent out in a group, the UA header is included only as a group header, not on the individual reports.



Any PIREP reporting hazardous phenomena is considered an urgent PIREP and must be prefixed with the header UUA. Hazardous phenomena are defined as reported tornadoes, funnel clouds, waterspouts, hail, severe icing, severe or extreme turbulence (including CAT), low-level wind shear, or volcanic eruptions.

PIREPs are transmitted directly to central data collection centers via computer terminals exactly as coded on the observation record. PIREPs are disseminated locally via electrowriter, computer local-area-network (LAN), facsimile, or other appropriate means. A typical PIREP would be entered for transmission as follows:

UA/OV KNGUO90100/TM 2213/FL250/TP C5/SK BKN160-180  
/WV 23057KT/TB LGT-MOD CAT 250-270/IC LGT RIME 160-180

An urgent PIREP may be entered with only limited data as follows:

UUA/OV PHNL270150/TM 0933/FL290/TP C9B/TB SEV CAT 310

## RECORDS

A PIREP log, such as a two- or three-ring binder, should be maintained to keep all completed PIREP code forms. When transmitted, a printed copy of the transmitted message is normally attached to the PIREP code form. These records should be reviewed frequently by the observation supervisor for proper coding. Completed PIREP forms may be retained on board for as long as they may be of use, usually 1 year, and then destroyed.

## REVIEW QUESTIONS

- Q11. *What is considered significant weather as it relates to PIREPS?*
- Q12. *What does the acronym "CAT" indicate?*
- Q13. *What instruction governs procedures for reporting and encoding PIREPS for Navy and Marine Corps activities?*
- Q14. *What does the text element indicator "/TP" signify?*
- Q15. *How would an overcast layer with a base of 12,000 feet and top of unknown height be encoded for a PIREP?*
- Q16. *What does the PIREP entry /TB SEV CAT ABV 350 indicate?*
- Q17. *When is the message type indicator "UUA" encoded?*

## SUMMARY

In this chapter, we have discussed in detail the TAP code and its importance to aviation safety. We also explained the procedures used to record and transmit PIREPS.

# ANSWERS TO REVIEW QUESTIONS

- A1. *NAVMETOCOMINST 3143.1, Aerodrome Forecast (TAF) Code.*
- A2. *TAFs are transmitted at 6-hour standard intervals at 0300, 0900, 1500, and 2100 UTC, and are valid for 24 hours.*
- A3. *Cumulonimbus.*
- A4. *Windshear conditions exist, but complete information cannot be reliably forecast.*
- A5. *610604.*
- A6. *Occasional moderate turbulence in clouds from 10,000 to 13,000 feet.*
- A7. *The lowest altimeter setting in inches expected during the forecast period.*
- A8. *The abbreviation "FM" is used to indicate the beginning of a change period in the forecast. Elements in this change group supersede all elements previously forecast.*
- A9. *TEMPO.*
- A10. *Wind speed change of 10 knots or more, directional change of 30° or more (when the mean wind speed or gusts are in excess of 15 knots), or when wind speed or directional change results in a change of an active runway.*
- A11. *Significant weather is any weather that may affect the flight performance of an air-craft, or is capable of causing injury or damage to personnel property on the ground, such as from icing, LLWS, lightning, etc.*
- A12. *Clear Air Turbulence.*
- A13. *NAVMETOCOMINST 3142.1, Procedures Governing Pilot Weather Reports (PIREPS).*
- A14. *Aircraft type information follows.*
- A15. */SK OVC120-UNKN.*
- A16. *Severe clear air turbulence above 35,000 feet.*
- A17. *The message type indicator "UUA" is used in the case of an urgent PIREP (hazardous weather encountered).*

## CHAPTER 4

# SURF OBSERVATIONS

### INTRODUCTION

Amphibious warfare is the most complex operation in modern warfare. The safety and success of amphibious landings are largely dependent upon known surf conditions, although several other environmental factors can also have a profound effect. Surf conditions are reported by various individuals, depending upon the specific operation. Their input into surf forecasts (SURFCSTS) are key to major decisions. In this chapter, we will begin by discussing the causes of surf and surf zone characteristics in general. We will then focus on the actual surf observation (SUROB) at a beach, and describe the calculation of the modified surf index (MSI). Finally, we will discuss in detail how tides affect amphibious operations.

### SURF ZONE CHARACTERISTICS

---

**LEARNING OBJECTIVES:** Identify the manual that provides information on surf zone terminology and detailed instruction on surf observation procedures. Identify the causes of surf. Recognize the effects of hydrography on surf conditions. Define the terms used in surf observations. Recognize the effects of refraction on waves.

---

On occasion, both Navy and Marine Corps weather observers may be called upon to support amphibious operations either in exercise conditions or in an actual beach assault. When the beach area is secure (in friendly hands), you may be tasked with observing and reporting surf conditions from the beach. Under hostile conditions, Navy UDT/SEALs or Marine Corps RECON personnel are normally tasked to conduct an on-scene, covert beach survey, which includes observing and reporting surf conditions. Aerial reconnaissance photography and satellite imagery can also provide a good indication of surf conditions at a hostile beach-landing area. Analysis of surf conditions from imagery is done by Navy and Marine Corps analysts/forecasters and Navy oceanographers working with photographic analysts.

COMNAVSURFLANT/PACINST 3840.1, *Joint Surf Manual*, contains comprehensive information on amphibious operations, including surf observation procedures and a listing of various tables used for surf index calculations. All Navy and Marine Corps surf observers should review the *Joint Surf Manual*.

### CAUSES OF SURF

*Surf*, the way that waves break near a beach, is caused by either local onshore winds or by swell waves traveling from a distant fetch area. The term *surf zone* describes the area between the shoreline and the outermost limit of the breakers. The surf zone encompasses the region between the first approaching breakers and the limit of wave uprush.

Surf created by local winds is characterized by breakers with irregular crests, short wave periods, and many whitecaps in the surf zone. Breakers produced by sea waves do not appreciably increase in height before they break. Surf created by swell waves produces breakers with a more rounded appearance and with a more regular, but longer period. Swell waves offshore appear low and rounded, but just before breaking they rapidly increase in height and steepness. Although sea waves and swell waves usually exist simultaneously, it is the swell that most often presents a problem for amphibious operations.

Surf forms as deep-water waves approach shallow water. Deep-water waves are waves moving over water that has a depth greater than one-half the average wavelength. Deep-water waves approaching the beach will “feel bottom” when the depth of the water is approximately one-half the deep-water wavelength. When a wave feels bottom, *wave speed* and *wavelength* decrease while *wave height* increases. As this happens, the face of the wave becomes steeper. The *steepness* of a wave refers to the ratio of wave height to wavelength.

Waves become breakers when the wave spills water down the face of the wave (the wave crest). Once the steepness of a wave becomes 1/7 of the wavelength, the wave becomes unstable and begins to break. When approaching a beach, a wave will normally break when the water depth is 1.3 times the wave height, but may

vary slightly depending on bottom topography. Thus, with 6-foot breakers, the breaker line is located where the depth to the bottom is about 8 feet.

### SURF ZONE HYDROGRAPHY

Besides the winds and seas, the hydrography of a beach has a major impact on the character of surf. The hydrography in a surf zone includes the water depth, nearshore currents, tides, the shoreline configuration, the beach slope (gradient), and bottom composition. In fact, the beach slope is the most important factor in determining the type of breaker most likely to be present. Due to dissipation over distance, waves breaking closer to shore will do so with less energy and lower heights than waves breaking farther offshore. Bottom features, such as ridges, canyons, sandbars, and troughs, can greatly affect where waves break. It is important to remember that ridges and sandbars will cause waves to break farther from shore and with stronger force. When waves are observed that consistently break in the same area from one day to the next, there is probably a submerged feature such as a sandbar or reef in the surf zone.

Knowledge of beach hydrography is essential to producing accurate surf forecasts. There are many sources of hydrographic data, including climatological charts and tables, intelligence reports, seal team reconnaissance reports, as well as high resolution shallow water satellite imagery. Keep in mind that sandbars and other bottom features shift with the tides and seasons. Therefore, the *more* recent any beach survey information is, the more accurate and useful it will be.

### DESCRIPTIVE TERMS RELATING TO SURF OBSERVATIONS

Many terms used to conduct a surf observation are unique to either the observation or to an amphibious assault. Every observer must know what these terms

mean in order to conduct a proper surf observation, commonly called a SUROB. See figure 4-1. The following factors greatly influence surf:

- *Beach orientation* or *beach face*—the true direction a person standing on the beach and looking out to sea would face,
- *Beach slope*—the ratio of the drop in bottom depth compared to the horizontal distance traveled in the surf zone (rise over *run*). Usually obtained by seal team surveys or from hydrographic charts.

DESCRIPTIVE TERM	SLOPE (every 1 unit of rise per unit of beach length)
Steep	Greater than 1:15
Moderate	1:15 to 1:30
Gentle	1:30 to 1:60
Flat	Less than 1:120

- *Coastal zone topography*—the presence of islands or other wave-blocking, offshore land masses that affect wave refraction (bending of wave trains).
- *Near-shore and offshore bottom hydrography*—the presence of underwater sandbars, ravines, reefs, or other features on the ocean bottom. Coral and rocks can cause hazards to personnel and equipment.
- *Sandbars*—formed as a result of sand transported by waves and currents. Unlike reefs, these are transitory in nature and change with the seasons and tides. They may be exposed during low tide and cause landing craft to become stuck. In addition, the volume of water carried over the bar must return seaward. The return flow may

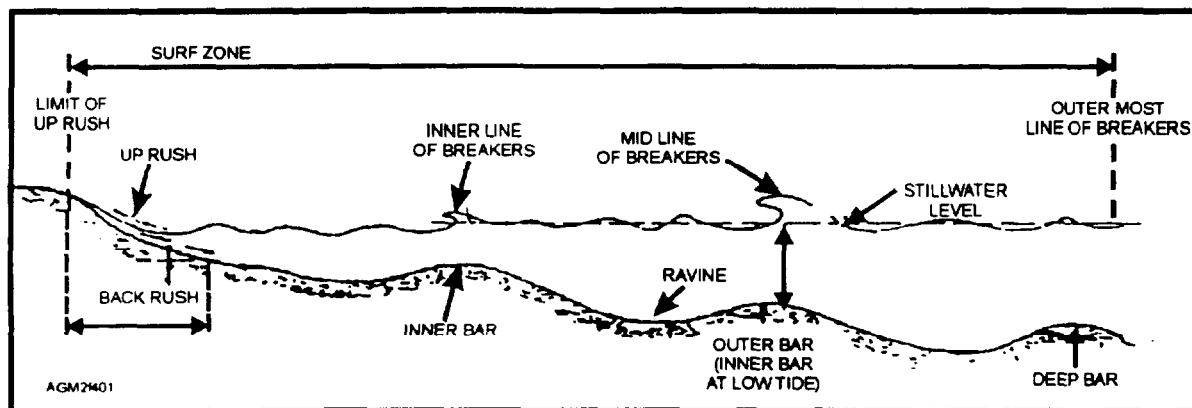

Figure 4-1.—Nearshore profile.

become focused and cut gaps or channels in the offshore bar. This return current is called a rip current. There may be several sandbars present in a surf zone.

The following factors normally will change in a short period of time (within 24 hours) and will affect the surf conditions you observe from the beach:

- Deep-water sea-wave height, direction, and period.
- Deep-water swell-wave height, direction, period, and the pattern of the waves within a swell-wave group.
- Presence of secondary wave systems that may create a more confused surf zone. These are discussed later in this chapter.
- Stage of the tides; that is, the height and pattern of the normal rise and fall in the water level.
- Set (direction) and drift (speed) of rising and falling tidal currents.
- Set and drift of semipermanent coastal water currents (usually obtained from hydrographic charts).
- Surf beat (the rise and fall of the entire water level within the surf zone). The surf beat is significant to landing craft approaching submerged obstacles, such as sandbars.
- Wind speed and direction.

Although all these factors must be evaluated when a forecast of surf conditions is calculated, you, as the observer, need to be aware of the factors that change with the weather and tides. Normally, your report of surf conditions, as affected by these changing factors, is evaluated by the forecaster. The forecaster then will interpret how forecasted deep-water waves will react when approaching the beach under various conditions.

## WAVE REFRACTION

Refraction is the bending of waves toward areas of slower wave speed. As a wave travels over shallower water and begins to interact with the bottom, the wave speed decreases. If the wave is traveling at an angle to the beach, the portion of the wave in shallow water slows down while the portion of the wave in deep water continues at the same speed, causing the wave to become more parallel to the beach. Wave refraction may also occur due to irregularities of the coastline and bottom contours. Waves will bend toward points protruding from shore due to the shallower water surrounding them. This process concentrates much more wave energy onto the protrusions than the embayments between them, as illustrated in figure 4-2. To predict variation in surf along a coastline, forecasters create refraction diagrams. Several different wave direction, height, and wave period scenarios may be used.

In the following text, we will discuss how to report observed surf conditions.

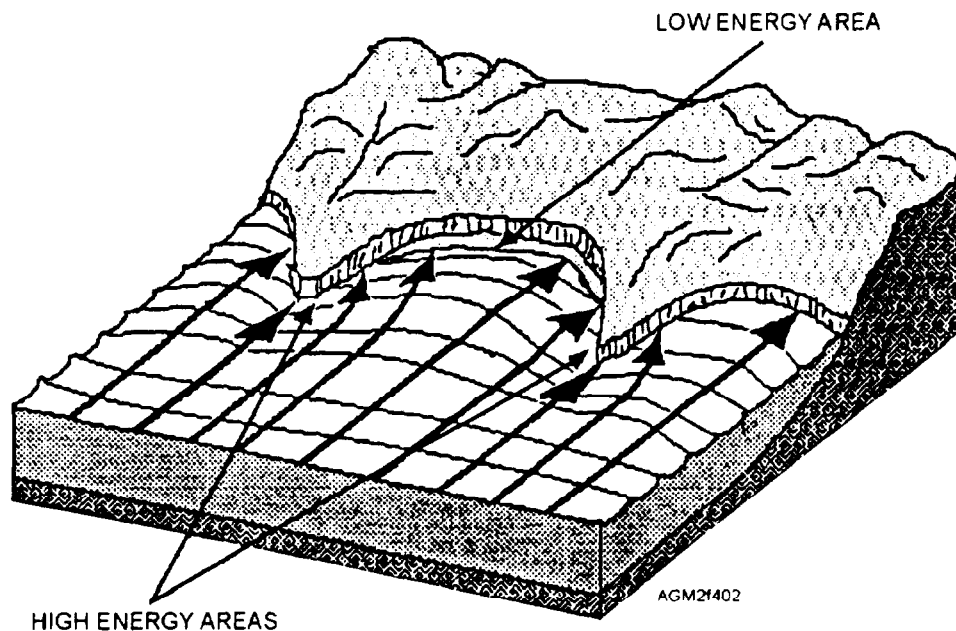

Figure 4-2.—Wave refraction due to coastal irregularities.

## REVIEW QUESTIONS

- Q1. What publication outlines procedures for conducting surf observations?
- Q2. What are two factors that can create surf?
- Q3. What are the boundaries of the surf zone?
- Q4. When a wave enters shallow water, what happens to the wave speed, wavelength, and wave height?
- Q5. How is wave steepness defined?
- Q6. The hydrography in a surf zone includes what elements?
- Q7. How does the presence of a sandbar effect waves moving into a surf zone?
- Q8. What descriptive term is used to classify a beach with a slope of 1:25?
- Q9. What affect might a sandbar have on small craft operations?
- Q10. What is meant by the term "wave refraction"?

## THE SURF OBSERVATION

---

**LEARNING OBJECTIVES:** Describe the procedures used to observe surf conditions. Describe how to record and transmit surf observations.

---

Surf observers report surf conditions by using a special code. Individual surf elements are reported by using standard designators, such as ALFA (to indicate significant breaker height), BRAVO (to indicate maximum breaker height), and so on. Surf forecasts (SURFCSTS) are issued in the same format and are just one part of the Amphibious Objective Area Forecast (AOAFCST) produced by forecaster personnel. SUROBs are recorded on a locally reproduced SUROB worksheet (fig. 4-3).

## BEACH FAMILIARIZATION

During amphibious operations, beaches are identified by color codes. A 3-mile-long section of beach, for example, may be broken down into shorter sections identified as Red Beach, Purple Beach, or Green Beach. Normally, even on an irregular coastline, planners try to divide the larger beaches into sections with similar characteristics. The orientation of the

beach and the beach slope should be fairly uniform for a beach called Green Beach, even though an adjacent beach area, perhaps called Red Beach, may have a dramatically different orientation and slope. In addition to color designations, beaches may also be identified by letter abbreviations alone. When tasked to provide SUROBs, you, the observer, must first familiarize yourself with the beach designations and boundaries involved, since separate observations may be required for each beach area.

## SURF OBSERVATION ELEMENTS

The SUROB worksheet is completed (and saved) for each individual SUROB. The observation number, the date and time of the observation (in UTC), and the beach identification are entered on each form as the first part of each SUROB report.

### Breaker Height (ALFA/BRAVO)

When observing the surf, you must observe the breaker heights of 100 individual breakers. Normally, breaker height is evaluated in an area where the waves are breaking nearest the beach. Breaker height is estimated to the nearest half-foot and is entered in the Wave Height Observation blocks on the SUROB worksheet. After observing 100 individual breakers, enter the *significant* breaker height, which is the average height of the highest one-third of all the observed breakers. Enter to the nearest 1/2 foot, as element ALFA on the SUROB report. Enter the maximum breaker height (the height of the single highest breaker observed) to the nearest 1/2 foot as element BRAVO.

Breaker heights are usually best estimated from a position close to the waterline on the beach. One fairly accurate method for estimating breaker height calls for the observer to line up the top of the breaker crest with the horizon. The height of the breaker is the vertical distance from this line to the seaward edge of the uprush zone. The *uprush zone* is the area on the beach where the waves cause the water to temporarily rush up on the sand, and then recede on the wave backwash to expose the sand. This method becomes less accurate as the distance from the observer to the breakers increases. See figure 4-4.

In cases where a longshore sandbar is present, the highest breakers may occur over the sandbar, with only smaller breakers occurring near the beach. This is the case at low tide. If you observe higher, more significant breakers offshore (over a submerged sandbar), enter



this information in the Remarks section, element HOTEL. An evaluation of the offshore breaker height and type should be included with the remarks. For example, HOTEL: HIGHER BREAKERS 50 YD OFFSHORE, ALFA 9 PT 0, BRAVO 12 PT 5, DELTA 80 PLUNG 20 SPILL. Elements CHARLIE, ECHO, FOXTROT, and GOLF need not be included in the remarks section.

**Breaker Period (CHARLIE)**

The total time (in seconds) for 100 successive waves to be observed, divided by 100, is the average breaker period. This value is entered to the nearest half-second as element CHARLIE of the report. The average breaker period is normally the same or very close to the deep-water wave period. Generally, breakers with shorter periods are much more difficult for landing craft to negotiate.

**Breaker Type (DELTA)**

Breakers are classified as spilling, plunging, or surging breakers, depending on their appearance (fig. 4-5). The steepness of the wave front, a function of the slope of the bottom, is the most critical factor as to what type of breaker will be formed. Bottom irregularities and local winds also influence breaker type. Keep in mind that breaker characteristics can vary considerably with respect to time and location.

*Spilling* breakers occur with gentle and flat beach slopes. As a wave moves toward the beach, steepness increases gradually and the peak of the crest gently slips down the face of the wave. The water at the crest of a wave may create foam as it spills over. Spilling breakers also occur more frequently when deep-water sea waves approach the beach. The shorter wavelength of a sea wave means that the wave is steeper in the deep water and that the water spills from the crest as the waves begin to feel bottom. Because the water constantly spills from the crest in shorter wavelength (shorter period) waves, the height of spilling waves rarely increases as dramatically when the wave feels bottom, as do the longer period waves. Because they occur on mild sloping beaches, spilling breakers typically produce surf zones that extend far offshore.

*Plunging* breakers occur with a moderate to steep beach slope. In this type of breaker, a large quantity of water at the crest of a wave curls out ahead of the wave crest, temporarily forming a tube of water on the wave face, before the water plunges down the face of the wave in a violent tumbling action. Plunging breakers

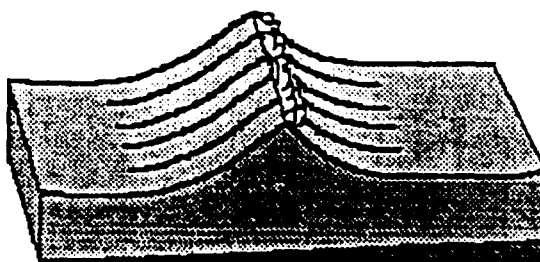

BEACH USUALLY FLAT

**A. SPILLING BREAKER**

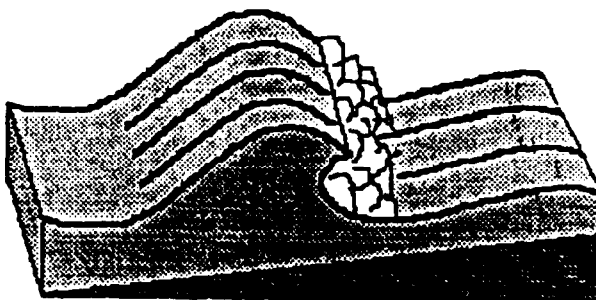

BEACH USUALLY MODERATE TO STEEP

**B. PLUNGING BREAKER**

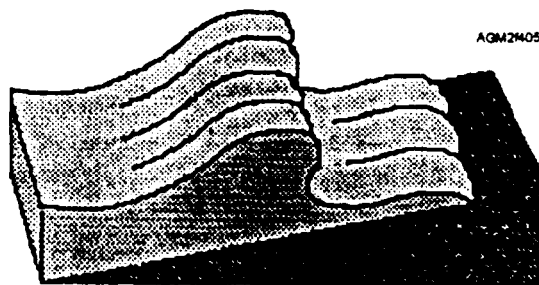

BEACH USUALLY VERY STEEP

**C. SURGING BREAKER**

**Figure 4-5.—General character of (A) spilling, (B) plunging, and (C) surging breakers.**

are characterized by the loud explosive sound made when the air trapped in the curl is released. Plunging breakers are more commonly associated with swell waves, which approach the beach with much longer wavelengths. The shortening of the wavelength as the wave feels bottom causes a great mass of water to build up in the crest in a short time. Longer period swell waves may double in height when feeling bottom



*Surging* breakers are normally seen only with a very steep beach slope. This type of breaker is often described as creating the appearance that the water level at the beach is suddenly rising and falling. The entire face of the wave usually displays churning water and produces foam, but an actual curl never develops. The water depth decreases so rapidly that the waves do not reach critical steepness until they are right on the beach. The entire wave surges up the beach and most of the energy is reflected back seaward. These wave can be very dangerous for landing craft. After the wave pushes the craft up the beach, the entire wave returns as a wall of water striking the craft.

Your determination of breaker height and breaker type is a very important part of the SUROB. The breaker type should be entered along with each entry of breaker height on the SUROB worksheet. Breaker type is to be evaluated for the same 100 breakers evaluated for height. All the breakers in the significant breaker area need not be the same type of breaker. You may, for instance, see three plunging breakers followed by four spilling breakers. The SUROB report requires that the

percentage of each type of breaker observed be entered as element DELTA.

### Breaker Angle (ECHO)

Because wave speed decreases as the waves enter shallower water, waves approaching the beach at an angle are refracted and approach the beach more parallel. Although waves are refracted, many situations produce breakers that approach the beach at an angle. Breaker angle is the angle the breaker makes with the beach, and is a critical factor in the creation of a littoral current. The greater the breaker angle, the stronger the littoral current.

Breaker angle must also be identified by the direction toward which the breakers are moving. Beach directions are identified by the direction as seen from an approaching landing craft. Looking from the sea toward shore, the left flank is toward a landing craft's left side (port side) and the right flank is toward the landing craft's right side (starboard side). See figure 4-6. Breaker angle is entered as element ECHO of the

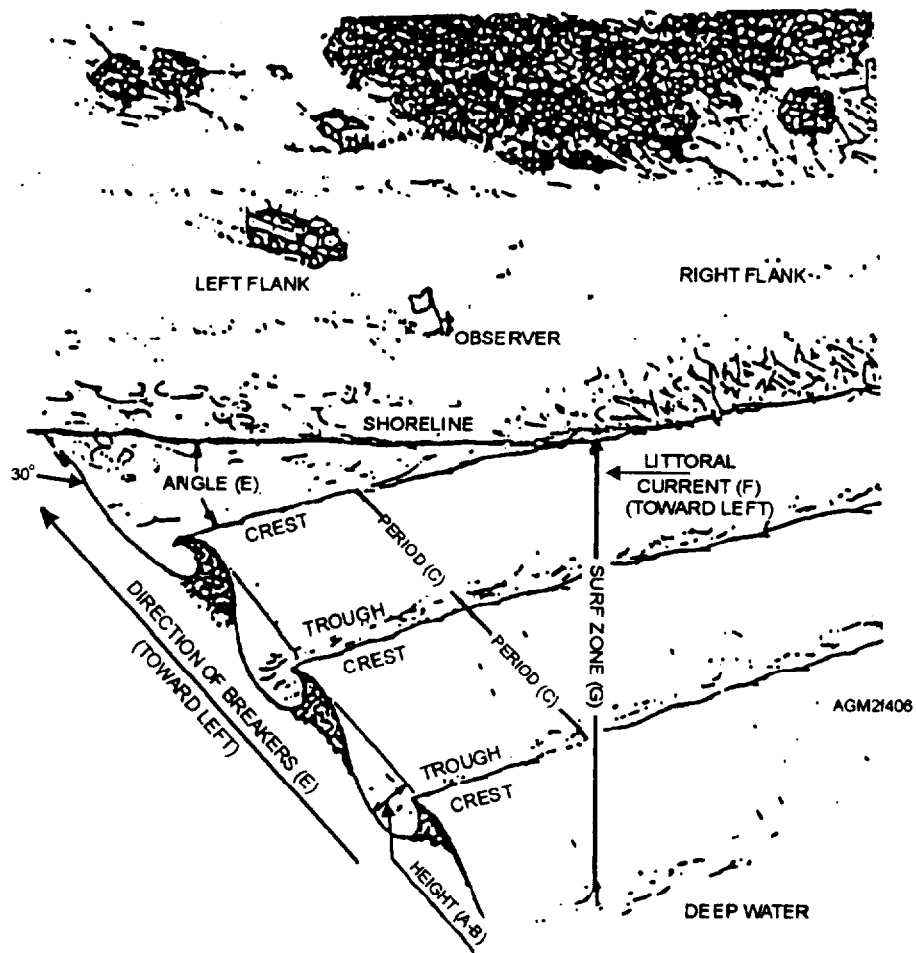

Figure 4-6.—Wave angle and beach directions. The wave angle in this case is about 30 degrees left flank.

SUROB. If several breaker angles exist and breaker lines are moving toward both flanks, the following entry is made: 10-20 toward R/L flank. If the breakers are directly parallel to the beach, the entry should be: 0 toward R/L flank.

### REVIEW QUESTIONS

- Q11. *During amphibious operations, how are individual beach sections identified?*
- Q12. *How is significant breaker height determined in a surf observation?*
- Q13. *Plunging breakers are associated with what type of waves?*
- Q14. *What type of breakers would you expect to find on a beach with a very steep slope?*
- Q15. *How do you determine the direction breakers are moving?*

### Littoral Current (FOXTROT)

The littoral current must be measured and reported in each SUROB. The littoral current, also called the longshore current, is the current produced by the transport of the water caused by the breaking action of the waves. As the waves approach the shore at an angle, water is pushed up onto the beach at the same angle, and generates a net flow of water or a current. This current runs parallel to the beach and may be amplified by the presence of a longshore sandbar. Littoral currents are significant in that they can cause landing craft to drift off course and miss designated landing areas. Littoral currents are more common on straight beaches.

The velocity of a littoral current will normally be higher on beaches with steep slopes, and will increase with increasing breaker height and breaker angle. Velocities may reach speeds of 3 to 4 knots. Tidal currents parallel to the shore may intensify the littoral current or create opposing offshore currents. The speed and direction of the littoral current are reported in section FOXTROT of the SUROB.

**MEASURING LITTORAL CURRENTS.**—the measurement of speed and direction of the littoral current is fairly simple. Throw a piece of wood or other debris in the surf immediately in front of the inner most breaker, and pace off the distance in feet that it moves in

1 minute. The distance traveled by the debris in 1 minute divided by 100 is the speed of the littoral current in knots (10 feet of travel is equal to 0.1 knot). Several measurements should be made and the average reported to the nearest 0.1 knot. The direction of movement, or set of the littoral current, must also be reported as toward the left or right flank of the beach, as seen from seaward.

**RIP CURRENTS.**—Rip currents are formed when opposing offshore currents bend sections of a littoral current seaward, creating rip currents (popularly but erroneously called riptides). Rip currents are caused by water piling up along the shore. The water flows parallel to the shore for a short distance until it meets an opposing current or is deflected by bottom irregularities. Rip currents consist of three parts, the feeder current or currents which flow parallel to the beach inside the breaker zone, the neck where the feeder current or currents converge and flow through the breakers in a narrow band or rip, and the head where the current widens and slackens outside the breaker line. Cusps (points) forming in the beach sand indicate rip currents are forming (fig. 4-7). An observer can usually distinguish a rip current as a stretch of unbroken water in the breaker zone where no breakers occur. The outer limit of the current in the head is usually marked by patches of foam and broken water similar to tide rips, and the head itself is usually discolored by suspended silt.

Although rip currents commonly exceed 0.5 knot (the sustained speed of a trained swimmer) and should be avoided by swimmers, rip currents frequently cut a deep channel perpendicular to the beach, which creates an area where the breaker heights are significantly lower than the prevailing surf. Rip current channels may, in rare cases, provide the easiest route through a surf zone for certain landing craft.

The presence of rip currents should be noted as a remark in element HOTEL of the SUROB report. In the rip current, the significant breaker height, ALFA, and maximum breaker height, BRAVO, should also be reported as a remark in element HOTEL. A position relative to the beach center may also be included. For example, the rip current may be reported as RIP CURRENT CHANNEL LEFT FLANK RED 30 YD WIDE ALFA 1 PT 5 BRAVO 2 PT 0.

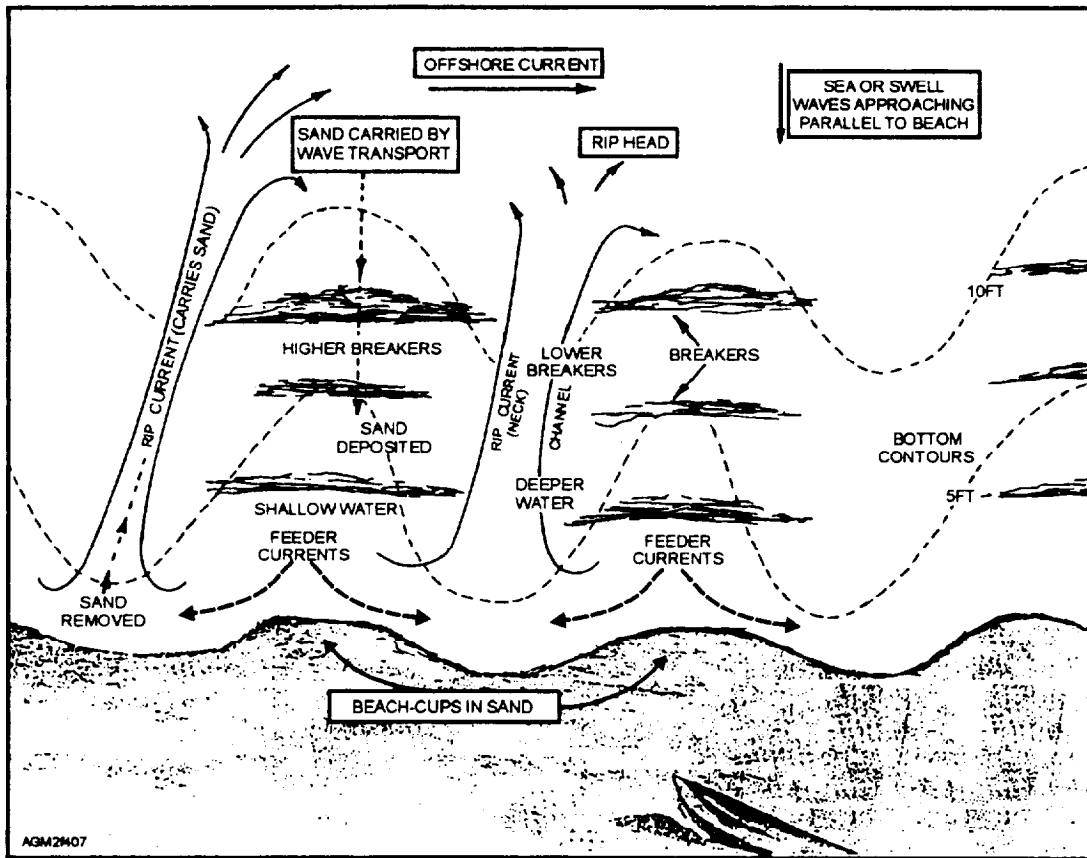

Figure 4-7.—Rip currents, beach cusps, and effect on breakers.

### Surf Zone (GOLF)

As mentioned earlier, the surf zone is the area from the water uprush outward to the point at which waves first show any indication of breaking. The width of the surf zone is another element reported in a SUROB. This distance is often estimated by looking up or down the beach from a high observation point. You should compare the width of the surf zone to the known width of the beach area. You must also report the lines of breaking waves seen within the surf zone (perpendicular to the beach) at any given time. A shallow sloped beach tends to have several lines of breakers, in different stages of breaking, in a wide surf zone. A steeper beach tends to have fewer lines of breaking waves in a relatively narrow surf zone. The width of the surf zone and the number of lines of surf in the surf zone are reported as element GOLF.

### Remarks (HOTEL)

Weather conditions, particularly wind data, are included as remarks in element HOTEL. In addition to the other remarks we have mentioned, brief comments about significant weather that may affect boat operations, such as low visibility or lightning, should be included. When weather personnel are assigned as SUROB observers, tactical surface weather observations may be taken in addition to the SUROB. This responsibility is normally assigned well in advance of an operation and will be described in the operation order.

When included, comments about the weather should be brief and in plain language; for example, HVY TSTRM WITH RAIN 10 NMI SE, CIG 030 BKN. or VSBY 7 NMI SEAWARD 2 NMI INLAND IN FOG.

**WIND REPORTS.**—Wind reports are mandatory. Winds should be reported as relative direction and speed. Estimate wind speed, and then determine wind direction, as shown in figure 4-8. Wind direction is always reported as the angle between the point from which the wind is blowing and a line normal to the beach. In addition, report the flank toward which the wind is blowing, and whether it is blowing from onshore or offshore. For example, winds would be reported as REL WIND 030° 15 KTS R FLANK ONSHORE or REL WIND 060° 08 KTS L FLANK OFFSHORE.

If true wind direction and speed measurements can be obtained, they should also be reported. For example, report TRUE WIND 320 AT 12 KT. The true wind direction and speed are used as inputs to modified surf index calculations by using the Tactical Environmental Support System (TESS) or the Mobile Oceanography Support System (MOSS).

Onshore winds are normally favorable to operations. Off-shore winds greater than 10 knots will tend to increase the surf zone, increase wave steepness, and produce a greater number of plunging breakers.

**SECONDARY SURF.**—Secondary surf is also a mandatory remark when applicable. When sea waves and swell waves or two sets of swell waves approach the beach from different directions, the breakers may occur in a large range of heights and periods, and the currents produced in the surf zone may be very erratic and dangerous. Information on the most significant set of breakers is reported in the main report. For example, report the larger breakers or report the breakers with the

shorter period if both wave sets produce breakers of equal height. Complete information on the secondary set of breakers is reported following HOTEL with a remark, such as SECONDARY SURF ALPHA . . . BRAVO. . . and so on, including all parameters ALFA through ECHO. Elements FOXTROT and GOLF are not reported for secondary surf. The effects attributed to the secondary surf cannot be separated from the evaluation of surf zone and littoral current. The presence of deep-water waves and the resulting lines of breakers approaching the beach from different directions are the primary factor requiring secondary surf to be reported.

### REVIEW QUESTIONS

- Q16. *How are littoral currents produced?*
- Q17. *What may cause littoral currents to increase in velocity?*
- Q18. *How can rip currents be identified in a surf zone?*
- Q19. *What information is contained in element GOLF in a surf observation?*
- Q20. *How should an onshore wind blowing at 045° at 12 knots, and blowing from left to right (as viewed from the beach) be reported in element HOTEL?*
- Q21. *What are the effects of secondary wave trains moving into a surf zone?*

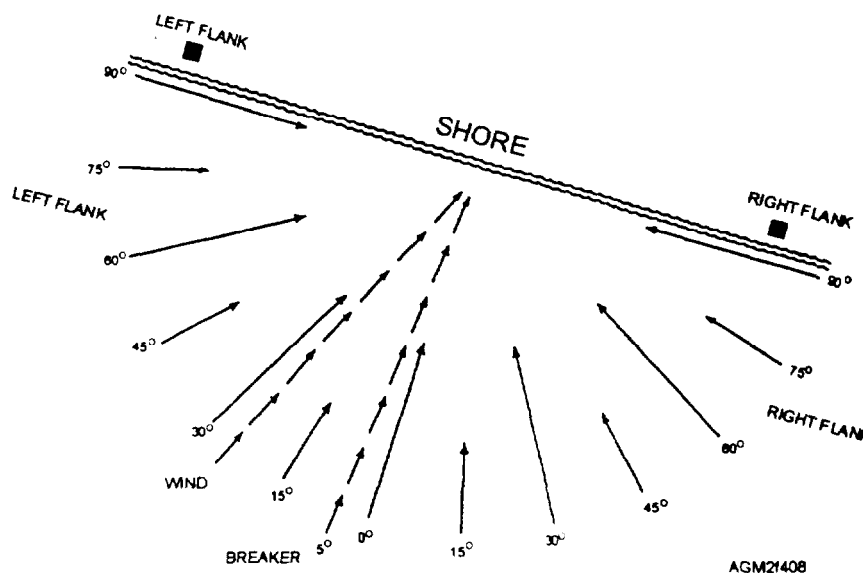

Figure 4-8.—Surf/wind angle diagram.

**MODIFIED SURF INDEX  
CALCULATION**

---

*LEARNING OBJECTIVES:* Describe the procedures used to calculate the Modified Surf Index (MSI). Identify features of the SURF program available in TESS/MOSS.

---

The modified surf index (MSI) is the most critical parameter in a waterborne assault. Both the SUROB observer and weather personnel aboard the task force command ship normally calculate the MSI from information contained in a SUROB. Additionally, surf forecasters at a center, facility, or detachment routinely

calculate the modified surf index as part of the surf forecast.

The modified surf index is a calculated, single dimensionless number used as an objective decision aid. It is an assessment of the combined effects of breakers, littoral current, and wind conditions on landing craft. If the MSI exceeds the MSI limit for a particular craft, the landing is not feasible with that type of craft without increasing the casualty rate. The modified surf index is calculated on a locally reproduced Modified Surf Index Calculation Worksheet, shown as table 4-1. Tables 4-2 through 4-6 are used in computing table 4-1.

**Table 4-1.—Modified Surf Index Calculation Worksheet**

<b>SUROB / SURFCAST NO. 5: VALID TIME: 2200Z - RED BEACH</b>		
<b>SURF REPORT ITEM</b>	<b>MODIFICATION</b>	<b>ENTRY</b>
SIG BREAKER HT (ALFA) 4.5 FT	No modification, enter significant breaker height.	+4.5
BREAKER PERIOD (CHARLIE) 7 SEC	Enter value from breaker period modification table (table 4-2).	+1.6
BREAKER TYPE (DELTA) 70% SPILLING 30% PLUNGING 0% SURGING (see note below)	NO ENTRY FOR 100% PLUNGING SURF. Enter only a value for the percent spilling surf or the percent surging surf from the breaker type modification tables (table 4-3).	-2.8
BREAKER ANGLE (ECHO) 15 DEG	Enter modification value from the breaker angle modification table (table 4-4) as value (A)= 2.4.	Enter only greater value, (A) or (B) +2.7
LITTORAL CURRENT (FOXTROT) 0.9 KT	Enter modification value from the littoral current modification table (table 4-5) as value (B)= 2.7	
RELATIVE WIND (HOTEL) 15 kt at 35 DEG ONSHORE	Enter the value from the wind modification table (table 4-6).	+0.5
SECONDARY SIG BREAKER HT (HOTEL-ALFA) OFT	No modification, enter secondary significant breaker height.	0
<b>(add all entries) - - - - MODIFIED SURF INDEX= 6.5</b>		
<b>NOTE: Surging breakers should occur on beaches with steep gradients and should not normally occur with spilling breakers.</b>		

Table 4-2.—Breaker Period Modification

<b>BREAKER PERIOD MODIFICATION</b>											
<b>MODIFICATION ENTRY</b>											
<b>P E R I O D</b>	≥17	0	0	-.1	-.2	-.3	-.4	-.5	-.6	-.8	-1.0
	16	0	0	-.1	-.1	-.2	-.2	-.3	-.4	-.5	-.7
	15	0	0	0	-.1	-.1	-.1	-.2	-.2	-.3	-.3
	14	0	0	0	0	0	0	0	0	0	0
	13	0	0	0	+1	+1	+1	+2	+2	+3	+3
	12	0	0	+1	+1	+2	+2	+3	+4	+5	+7
	11	0	0	+1	+2	+3	+4	+5	+6	+8	+1.0
	10	0	+1	+1	+2	+3	+5	+7	+9	+1.1	+1.3
9	0	+1	+1	+3	+3	+6	+8	+1.1	+1.3	+1.7	
≤8	0	+1	+2	+3	+5	+7	+1.0	+1.3	+1.6	+2.0	
		.5	1	1.5	2	2.5	3	3.5	4	4.5	≥5
<b>SIGNIFICANT BREAKER HEIGHT (FT)</b>											

Table 4-3.—Breaker Type Modification

<b>BREAKER TYPE MODIFICATION</b>												
<b>MODIFICATION VALUE (A)</b>												
<b>S P I L L I N G</b>	%	100	-.1	-.2	-.5	-.8	-1.3	-1.8	-2.5	-3.2	-4.1	-5.0
		90	0	-.2	-.4	-.7	-1.1	-1.6	-2.2	-2.9	-3.6	-4.5
		80	0	-.2	-.4	-.6	-1.0	-1.4	-2.0	-2.6	-3.2	-4.0
		70	0	-.1	-.3	-.6	-.9	-1.3	-1.7	-2.2	-2.8	-3.5
		60	0	-.1	-.3	-.5	-.8	-1.1	-1.5	-1.9	-2.4	-3.0
		50	0	-.1	-.2	-.4	-.6	-.9	-1.2	-1.6	-2.0	-2.5
		40	0	-.1	-.2	-.3	-.5	-.7	-1.0	-1.3	-1.6	-2.0
		30	0	-.1	-.1	-.2	-.4	-.5	-.7	-1.0	-1.2	-1.5
	20	0	0	-.1	-.2	-.3	-.4	-.5	-.6	-.8	-1.0	
	10	0	0	0	-.1	-.1	-.2	-.2	-.3	-.4	-.5	
			.5	1	1.5	2	2.5	3	3.5	4	4.5	5
<b>SIGNIFICANT BREAKER HEIGHT (FT)</b>												
<b>MODIFICATION VALUE (B)</b>												
<b>S U R G I N G</b>	%	100	+1	.2	.5	.8	1.3	1.8	2.5	3.2	4.1	5.0
		90	0	.2	.4	.8	1.2	1.7	2.3	3.0	3.8	4.7
		80	0	.2	.4	.7	1.1	1.6	2.2	2.8	3.6	4.5
		70	0	.2	.4	.6	1.0	1.5	2.0	2.7	3.4	4.2
		60	0	.2	.3	.6	1.0	1.4	1.8	2.5	3.1	3.9
		50	0	.1	.3	.6	.9	1.3	1.7	2.3	2.9	3.5
		40	0	.1	.3	.5	.8	1.1	1.5	2.0	2.6	3.2
		30	0	.1	.2	.4	.7	1.0	1.3	1.8	2.2	2.7
	20	0	.1	.2	.4	.6	.8	1.1	1.4	1.8	2.2	
	10	0	.1	.1	.3	.4	.6	.7	1.0	1.3	1.6	
			.5	1	1.5	2	2.5	3	3.5	4	4.5	5
<b>SIGNIFICANT BREAKER HEIGHT (FT)</b>												

Table 4-4.—Breaker Angle Modification

<b>BREAKER ANGLE MODIFICATION</b>											
<b>BREAKER ANGLE MODIFICATION VALUE</b>											
<b>A</b>	40	+0.1	.3	.7	1.3	2.0	2.9	3.9	5.1	6.5	8.0
<b>N</b>	35	.1	.3	.6	1.1	1.8	2.5	3.4	4.5	5.7	7.0
<b>G</b>	30	.1	.2	.5	1.0	1.5	2.2	2.9	3.8	4.9	6.0
<b>L</b>	25	.1	.2	.5	.8	1.3	1.8	2.5	3.2	4.1	5.0
<b>E</b>	20	0	.2	.4	.6	1.0	1.4	2.0	2.6	3.2	4.0
	15	0	.1	.3	.5	.8	1.1	1.5	1.9	2.4	3.0
<b>D</b>	10	0	-.1	.2	.3	.5	.7	1.0	1.3	1.6	2.0
<b>E</b>	5	0	0	.1	.2	.3	.4	.5	.6	.8	1.0
<b>G</b>											
		.5	1	1.5	2	2.5	3	3.5	4	4.5	25
<b>SIGNIFICANT BREAKER HEIGHT (FT)</b>											

Table 4-5.—Littoral Current Modification

CURRENT (knots)	MODIFICATION	CURRENT (knots)	MODIFICATION
0.1	0.3	1.7	5.1
0.2	0.6	1.8	5.4
0.3	0.9	1.9	5.7
0.4	1.2	2.0	6.0
0.5	1.5	2.1	6.3
0.6	1.8	2.2	6.6
0.7	2.1	2.3	6.9
0.8	2.4	2.4	7.2
0.9	2.7	2.5	7.5
1.0	3.0	2.6	7.8
1.1	3.3	2.7	8.1
1.2	3.6	2.8	8.4
1.3	3.9	2.9	8.7
1.4	4.2	3.0	9.0
1.5	4.5		

**Table 4-6.—Relative Wind Modification**

RELATIVE WIND MODIFICATION							
		WIND MODIFICATION					
<b>W</b>	36-40KT	+2.0	3.0	4.0	1.5	2.0	4.0
<b>I</b>	31-35KT	1.5	2.0	3.0	1.0	1.5	3.0
<b>N</b>	26-30KT	1.0	1.5	2.0	0.5	1.0	2.0
<b>D</b>	21-25KT	0.5	1.0	1.5	0.0	0.5	1.5
	16-20KT	0.0	0.5	1.0	0.0	0.0	1.0
<b>S</b>	11-15KT	0.0	0.5	1.0	0.0	0.0	1.0
<b>P</b>	06-10KT	0.0	0.0	0.5	0.0	0.0	0.5
<b>E</b>	0-05KT	0.0	0.0	0.0	0.0	0.0	0.0
<b>E</b>		00-30°	30-60°	60-90°	00-30°	30-60°	60-90°
<b>D</b>		ONSHORE			OFFSHORE		
<b>WIND DIRECTION RELATIVE TO BEACH FACE</b>							

The operation go/no-go decision is usually made by comparing the MSI (6.5 in the example) to the maximum, safe operating limits for each type of craft provided in the *Joint Surf Manual*. The SUROB observer should not be expected to make any recommendations, but may be expected to provide the modified surf index calculation. Recommendations will be made by the forecaster. The MSI can also be computed from the SURF program in TESS and MOSS by using input from the surf observation. In addition to MSI calculations, the SURF program produces a surf forecast based on forecasted sea/swell, wind, and tide information. Beach profiles can be created by manually entering distance versus depth information obtained from beach survey charts. This is usually accomplished by the observer.

**REVIEW QUESTIONS**

- Q22. *What is the purpose of the Modified Surf index?*
- Q23. *When calculating the MSI what will be the value for a surf zone with 60% surging breakers and a significant breaker height of 3 feet?*
- Q24. *When calculating the MSI, what will be the value for a surf zone with an offshore wind at 70° relative at 23 knots?*
- Q25. *What program in TESS/MOSS can be used to compute MSI?*

**SUROB REPORTING**

---

*LEARNING OBJECTIVES:* Explain when surf observations are reported. Explain the purpose of the SUROB Brevity Code.

---

Depending on conditions of the seas, tides, and winds, SUROBS may show significant changes every hour. No standard reporting times or reporting intervals have been established. The *Joint Surf Manual* recommends at least one SUROB every 12 hours, 2 to 3 days before an operation, and then increasing to hourly within 6 hours of the landing. Normally, operation planners will establish minimum reporting intervals and assign a time to commence observations and reports. The observer should routinely monitor the surf conditions and submit intermediate or supplemental reports whenever conditions change significantly. Nighttime surf observations are not nearly as reliable as daytime observations. Trends noted in the Modified Surf Index in combination with current meteorological parameters, such as wind and sea state, may provide the best estimate of actual surf conditions at night.



## SUROB REPORTS

SUROBs are first passed to the Commander of the Amphibious Task Force (CATF), who normally remains on board the task force command and control ship. Reports are also forwarded to the command ship weather office and to the Naval Meteorology and Oceanography Command Center, facility, or detachment assigned forecast responsibility for the exercise or operation. These responsibilities are assigned in the weather support annex of the operation order.

SUROBs are normally passed via voice radio from the beach to the command ship. In a few situations, a copy of the SUROB worksheet may be passed directly to the CATF, or passed via light signal or flag semaphore. Before and during actual assault conditions, communications are heavily overloaded with critical command and control traffic and tactical traffic. Although the SUROB is equally as critical to the success of the operation, the message should be kept as brief as possible. In some cases, SUROBs are sometimes passed using the SUROB Brevity code.

## SUROB BREVITY CODE

The SUROB Brevity code is a standardized method of encoding and transmitting surf observations by voice or flashing light when speed is essential. The Brevity code uses only letters to pass information. When passing these messages via voice radio, each letter is pronounced using the phonetic alphabet that you learned in the *Basic Military Requirements* (BMR) course. The message is passed as tactical traffic to the weather office aboard the command ship. Normally, the Brevity code is decoded by the weather office and forwarded to users in the task group in the standard SUROB report format. Only SUROB observers and personnel in the command ship weather office need to be familiar with the SUROB Brevity code.

The complete observation might appear as: WSKCC SUGGY ILELC JYBXC AW. The identifying features of the Brevity code are the first two letters, which are always WS, and the arrangement in a few groups of five letters. Complete instructions for encoding and decoding a message using the SUROB Brevity code are contained in COMNAV-SURFLANTINST/COMNAVSURFPACINST 3840.1, *Joint Surf Manual*.

In the following text, we discuss the influence of tides on surf and some of the sources for obtaining tidal data.

## REVIEW QUESTIONS

- Q26. *How can surf conditions be estimated at night?*
- Q27. *Who are the primary users of SUROB information?*
- Q28. *What is the purpose of the SUROB Brevity code?*

## TIDES

---

**LEARNING OBJECTIVES:** Recognize how tides influence surf. Identify the various methods for obtaining tidal data.

---

Tidal influences have little effect on the height of breakers but can have a profound effect on the width and character of the surf zone, the strength of rip currents, and sediment transport. As the water level rises and falls due to the daily change in tides, the water flow creates currents. These currents flow toward the shore as a *flood* current with the rising tide and away from the shore as an *ebb* current with a falling tide.

## TIDAL EFFECTS IN THE SURF ZONE

During a tidal cycle, the position of the surf zone is shifted with the tide both vertically and horizontally, causing the intertidal beach profile to be slightly altered every 12 hours. In rip current systems, rips are strongest at low tide, when the water is sufficiently shallow to concentrate the flow of the current within the rip channels. Maximum rip current velocities occur during the falling tide, and on most beaches, rips become better developed when the tide is falling or low. Offshore bottom flow also increases during the falling tide. In addition, an increase in tidal range will result in an increase in sediment transport. This has a tendency to reduce beach gradients.

Normally, the surf zone will be wider at low tide than at high tide, given the same size waves. This is because the water level is lower and waves will begin to interact with the bottom farther from shore and break earlier. This wider surf zone can make the transit to the beach more difficult, and may cause equipment damage and troop fatigue. Also, sandbars and other obstacles, which have sufficient clearance at high tide, may be

barely covered at low tide. This can cause landing craft to become hung up or beach prematurely. See figure 4-9.

## TIDE CALCULATION

Semidiurnal tides consists of two low tides and two high tides in a 24-hour period in which each successive high and low water periods have nearly the same height. Diurnal (daily) tides consist of one low tide and one high tide in a 24-hour period. Mixed tides are semidiurnal tides in which each successive high and low water periods have different heights.

Tidal information is usually obtained from Quartermaster personnel, but is available from publications and prepared tables. A Tidal Prediction Program (TIDE) is available in TESS and MOSS using location-specific tide data. The TIDE program calculates hourly tidal information only for locations contained in the data base. However, adjustments can be made for substations using time and height corrections. Tidal currents are not predicted by the TIDE program. However, tidal currents can be

estimated from tidal current tables produced by the National Imagery and Mapping Agency.

## REVIEW QUESTIONS

- Q29. *A flood current is associated with what type of tide?*
- Q30. *When are rip currents strongest?*
- Q31. *Why is the surf zone normally wider at low tide?*
- Q32. *Where can tidal information be obtained?*

## SUMMARY

Although you may rarely, if ever, be tasked to provide SUROBs, you must be familiar with the observation procedures and the terms used to describe surf conditions. In this chapter, we have explained the causes of surf and discussed nearshore hydrography and several key terms used in surf observations. We covered the actual surf observation (SUROB) and the calculation of the Modified Surf Index (MSI). We also discussed tides and their impact on surf.

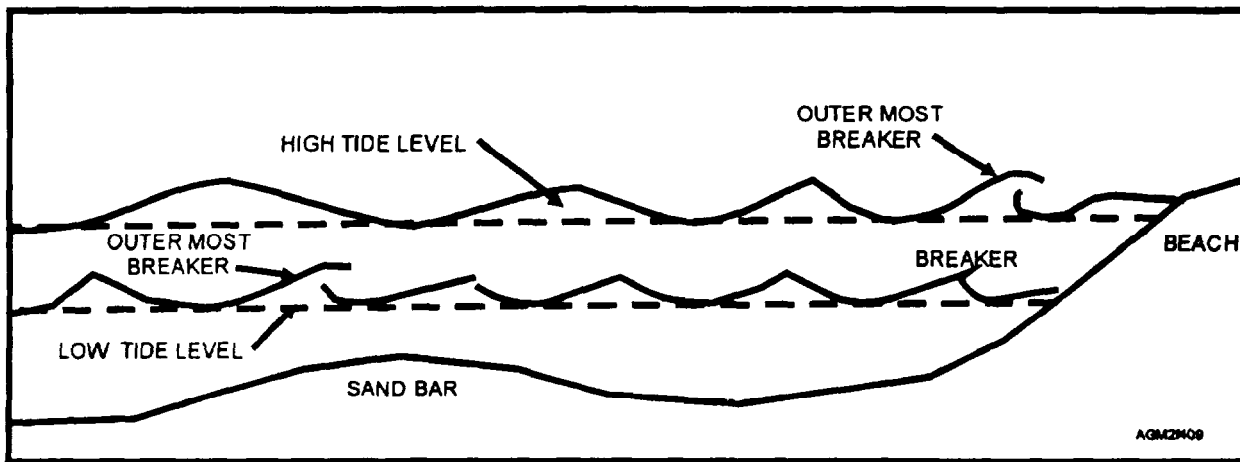

Figure 4-9.—Effects of tides on surf zone.

# ANSWERS TO REVIEW QUESTIONS

- A1. *COMNAVSURFLANT/PACINST 3840.1 (Joint Surf Manual).*
- A2. *Local onshore winds (creating sea waves) and swell waves traveling from distant fetch areas.*
- A3. *The area between the shoreline and the outermost limit of the breakers*
- A4. *Wave speed decreases, wavelength decreases, and wave height increases,*
- A5. *The ratio of wave height to wavelength.*
- A6. *Hydrography includes water depth, near-shore currents, tides, shoreline configuration, the beach slope, and bottom composition.*
- A7. *Sandbars will cause waves to break farther from shore and with stronger force.*
- A8. *Moderate.*
- A9. *Sandbars may be exposed during low tide and cause landing craft to become hung-up on the bar.*
- A10. *Wave refraction is the bending of waves toward areas of slower wave speed caused by interaction with the ocean bottom.*
- A11. *By color code or letter abbreviations.*
- A12. *Significant breaker height is the average height of the highest one-third of the 100 waves observed, recorded to the nearest half-foot.*
- A13. *Swell waves.*
- A14. *Surging breakers.*
- A15. *The direction of breakers is determined by the direction the breakers are moving toward as seen from seaward.*
- A16. *Littoral currents are produced by waves approaching the shore at an angle, generating a net flow of water along the beach.*
- A17. *An increase in breaker angle and/or breaker height.*
- A18. *Rip currents may be identified as a stretch of unbroken water in the breaker zone where no breakers occur. The outer limit of the rip current is usually an area marked by patches of foam, and discolored by suspended silt.*
- A19. *The width of the surf zone and the number of breaker lines*
- A20. *REL WIND 045° 12 KTS L FLANK ONSHORE.*

- A21. *Secondary wave systems create a more confused surf zone. with a large range of breaker heights and breaker periods, and littoral currents that may be erratic.*
- A22. *The Modified Surf Index (MSI) provides an objective decision aid for amphibious planners that assesses the combined effects of breakers, littoral currents, and winds on landing craft.*
- A23. +1.4
- A24. +1.5
- A25. *The SURF program.*
- A26. *The most recent trends in the Modified Surf Index should be evaluated along with current meteorological parameters, such as wind and sea state.*
- A27. *The Commander, Amphibious Task Force (CATF), the command ship weather office, and the Naval Meteorology and Oceanography Command assigned forecast responsibilities for the operation.*
- A28. *To transmit SUROB information via voice or flashing light when speed is essential.*
- A29. *A rising tide (high tide).*
- A30. *A falling tide (low tide).*
- A31. *The surf zone is normally wider at low tidesince the water level is lower and waves will begin to interact with the bottom farther from the shore.*
- A32. *Tidal information can be obtainedfrom Quartermaster personnel, publications, prepared tables, charts, and the TIDE program in TESS/MOSS.*

## CHAPTER 5

# PLOTTING RADIOLOGICAL FALLOUT AND CHEMICAL CONTAMINATION COVERAGE

### INTRODUCTION

In military warfare operations, nuclear, biological, and chemical (NBC) weapons may be employed by either friendly or opposing forces with little warning. Marine Corps observers are the personnel that are primarily concerned with plotting nuclear fallout and chemical contamination areas ashore. However, due to the large number of Naval installations ashore and the increasing emphasis on joint operations between Army, Air Force, Marine, Special Operations, and Naval forces, naval weather observers must be familiar with plotting and predicting fallout and dispersion patterns for nuclear and chemical weapons both ashore and at sea. Biological weapons are of concern to Navy and Marine Corps operations, but the contamination hazard from these weapons depends on the methods used to deliver the agent. Biological agents are also very difficult to detect or predict.

### NATO NBC REPORTING SYSTEM

---

**LEARNING OBJECTIVES:** Identify the publication that governs the NATO nuclear, biological, and chemical (NBC) warfare prediction and warning system. Identify the types of reports used in the NATO NBC prediction and warning system. Recognize the differences between NBC messages relating to ground forces and NBC messages relating to Naval forces.

---

The Allied Tactical Publication No. 45 (ATP-45), *Reporting Nuclear Detonations, Biological and Chemical Attacks, and Predicting and Warning of Associated Hazards and Hazard Areas*, covers in detail the procedures used by NATO forces to report nuclear, biological, or chemical weapons employment, and to estimate hazards associated with these weapons. The publication also provides detailed information on calculating and plotting nuclear, chemical, and biological hazard areas.

In the NATO system, six types of messages are used to report and track hazards associated with NBC weapons:

- NBC 1 (NUC, BIO, or CHEM)—initial report of NBC weapons use.
- NBC 2 (NUC, BIO, or CHEM)—follow-up report of evaluated data.
- NBC 3 (NUC, BIO, or CHEM)—effective downwind message.
- NBC 4 (NUC, BIO, or CHEM)—survey results.
- NBC 5 (NUC, BIO, or CHEM)—report of areas with contamination.
- NBC 6 (NUC, BIO, or CHEM)—report of details of chemical or biological attack.

When these messages are originated by Naval Forces, or composed specifically for transmission to Naval Forces, the abbreviation *NAV* precedes the report title, such as *NAV NBC 3 NUC*. Naval NBC messages use geographical coordinates for locations, nautical miles for distances, true degrees for directions, and knots for speeds. Ground forces, however, report all positions in (UTM) coordinates, distances in kilometers, directions in degrees or mils (see Appendix V), and speeds in kilometers per hour. All times are in Coordinated Universal Time (UTC). You must be able to convert between the systems of coordinates and measurements, as explained earlier in AG module 1.

### PLOTTING RADIOLOGICAL FALLOUT

---

**LEARNING OBJECTIVES:** Plot nuclear hazard areas by using information in either an effective downwind forecast (EDF) or an actual NATO nuclear detonation effective downwind message (EDM). Identify the different types of nuclear bursts.

---

Radiological fallout patterns may be plotted using two types of products. In advance of any nuclear attack, a nuclear effective downwind forecast (EDF) provides general information to determine where and how far the

Manop Header with transmit time	
Title and Valid Time	
IX AdddFFFa BdddFFFa CdddFFFa DdddFFFa EdddFFFa FdddFFFa GdddFFFa	
FXEU21 EDZX 110915Z	Header
EFFECTIVE DOWNWIND MESSAGE ZULU 110600Z 11 JAN 1000Z - 1600Z	Valid Time
NL A004 - - - B133009/ C134014/ D135016/ E136020/ F1530156 C1520206	1st area
NM A010010/ B142012/ C145017/ D150020/ E150021/ F160019/ G160022/	2nd area
	etc.

Figure 5-1.—Format and example of a typical Effective Downwind Forecast (EDF).

fallout will be carried. After a nuclear device has been detonated, and the actual weapon yield has been determined, a nuclear effective downwind message (EDM) provides specific predicted fallout areas for that weapon. Both types of products are discussed in the ATP-45. The following text discusses how to interpret the various types of nuclear effective downwind forecast products and the actual NBC 3 NUC reports.

**NUCLEAR EFFECTIVE DOWNWIND FORECAST**

Many computerized forecast centers routinely compose and transmit messages containing forecasts of effective nuclear fallout wind directions and speeds. When produced specifically for ground forces, the messages are entitled *Effective Downwind Message*, or *Effective Downwind Forecast*. When produced specifically for Naval Forces, the messages are entitled

*Naval Effective Downwind Message* or *Naval Effective Downwind Forecasts*. For simplicity, we will call these products effective downwind forecasts (EDF). The primary difference between ground-force messages and naval messages is that naval messages give locations in geographical coordinates, distances in nautical miles, and wind speed in knots, while the messages for ground forces have locations in UTM coordinates, distances in meters or kilometers, and wind speeds in kilometers per hour. Figure 5-1 shows the standard EDF message format, and a typical EDF message.

In the message heading (fig. 5-1), the term *ZULU* precedes the date-time of the wind observation on which the forecast is based. In the format, the *IX* is the area indicator used to identify the two-letter UTM coordinate 100,000 meter-square grid, such as *NL* or *NM*. The letters *A* through *G* identify the yield groups, as shown in table 5-1. For each weapon-yield group, the *ddd* is the effective-downwind direction (direction

Table 5-1.—Yield Groups Used in Effective Downwind Forecasts

Yield GROUP	RANGE
A = ALPHA	2 kilotons (KT) or less
B = BRAVO	more than 2 kilotons (KT) to 5 kilotons (KT)
C = CHARLIE	more than 5 kilotons (KT) to 30 kilotons (KT)
D = DELTA	more than 30 kilotons (KT) to 100 kilotons (KT)
E = ECHO	more than 100 kilotons (KT) to 300 kilotons (KT)
F = FOXTROT	more than 300 kilotons (KT) to 1 megaton (MT)
G = GOLF	more than 1 megaton (MT) to 3 megatons (MT)

towards which the wind is blowing) in true degrees, while the *FFF* is the effective-downwind speed in kilometers per hour. The *a* is the expansion angle indicator, which is encoded as a "/" if only the 40° standard angle is to be used. Expansion angle indicators are provided in table 5-2. Predictions for several areas may be contained in a single message.

**Table 5-2.—Expansion Angle Indicators**

INDICATOR	EXPANSION ANGLE
/	40°
5	50°
6	60°
7	70°
8	80°
9	90°
0	100°
1	110°
2	120°
3	greater than 120°
-	CIRCLE AROUND GZ (wind speed less than 5 knots)

For a naval effective downwind forecast message (NAV EDM), the units used are slightly different. The area of validity, instead of being given as a UTM grid square, is provided as 5° latitude and longitude squares centered on the intersections of the latitude/longitude lines. For example, *2800N 09500W* represents a 5° square centered at 28° 00'N 095° 00'W. Directions are in true degrees, but all downwind distances are in nautical miles.

Additionally, the format may be different, depending on the organization producing the forecast. The yield groups *Alpha* through *Golf* may be listed in a vertical column instead of a horizontal row, as shown in figure 5-2. The first three digits are the effective downwind direction, while the last three digits are the effective downwind speed. The number in parenthesis is the expansion angle. In both ground force and naval force EDFs or EDMs, when the effective downwind speed is less than 8 KPH (5 knots), the radius of a circular fallout pattern is given by the first three digits, which are followed by three dashes.

Most of the effective downwind forecasts you will actually use are produced on site by the Tactical Environmental Support System (TESS). TESS calculates fallout patterns based on a specific weapon yield and input from a specified radiosonde data set. In addition to a dosage rate plot, TESS provides both English and Metric data similar to the NATO standard,

DFXX KNWC 111415Z			
24HR NAVAL EFFECTIVE DOWNWIND FORECAST VALID 121200Z NOV 96			
ZULU 111200Z			
	3000N 12500W	3000N 12000W	3000N 11500W
ALPHA	130008	125008	005---
BRAVO	135010	130008	007---
CHARLIE	145015(060)	140012	135009
DELTA	155020(060)	150018(050)	145015
ECHO	160022(060)	155021(060)	150018
FOXTROT	180025(070)	175026(070)	170023(060)
GOLF	180030(070)	180029(070)	180026(060)
Each line element is composed as follows:			
FOXTROT	180	025	(070)
yield group	downwind direction	downwind speed	expansion angle

**Figure 5-2.—Typical Naval Effective Downwind Message (NAV EDM).**

UNCLASSIFIED	RADFO ATP-45	OUTPUTS
		ENGLISH
CLOUD RADIUS	4.9	NM
EFFECTIVE DOWNWIND DIRECTION	135.	DEG
EFFECTIVE FALLOUT WIND SPEED	24	KNOTS
SECTOR ANGLE	40.	DEG
DISTANCE TO ZONE 1	52.8	NM
DEPOSITION BOUNDARY	1156.5 TO 1183.0	NM
		METRIC
CLOUD RADIUS	9.0	KM
EFFECTIVE DOWNWIND DIRECTION	135.	DEG
EFFECTIVE FALLOUT WIND SPEED	45	MIS
SECTOR ANGLE	40	DEG
DISTANCE TO ZONE 1	97.7	KM
DEPOSITION BOUNDARY	2041.6 TO 2190.7	KM
1018002 MAY97 2800N 09300W		UNCLASSIFIED

Figure 5-3.—Example of a TESS RADFO ATP-45 output.

as discussed in ATP-45. Figure 5-3 shows a typical TESS RADFO (radiation fallout) output for a 200 KT weapon.

The effective downwind forecast message and the TESS outputs are used mostly for planning purposes. For example, a task force commander may ask what the fallout pattern would be if a 20 KT weapon were to be detonated at some location. You would either have TESS calculate the parameters for you using the latest upper-wind data, or you would use an EDF containing the various yield groups for the area covering the specific location. The fallout pattern is then plotted on an appropriate chart. In this case, you would use the EDF message CHARLIE group, which is a forecast for all weapons in the 5-KT to 30-KT range. Keep in mind that the TESS RADFO program should not be used for high altitude bursts and deep-water bursts. The actual plotting procedure is discussed in the next section.

### REVIEW QUESTIONS

- Q1. What does the term "NBC warfare" mean?
- Q2. What NATO publication outlines procedures for reporting and plotting NBC warning hazard areas?

- Q3. How many types of NBC reporting messages are used and how do NBC messages for ground forces and NBC messages for naval forces differ?
- Q4. What is the basic difference between an Effective Downwind Forecast (EDF) and an Effective Downwind Message (EDM)?
- Q5. What does yield group "DELTA" indicate in an EDF message?

### NUCLEAR EFFECTIVE DOWNWIND MESSAGE

Of the six NATO NBC reports previously mentioned, you will be primarily concerned with the NAV NBC 3 NUC or NBC 3 NUC when plotting nuclear fallout patterns.

When a report of evaluated information is composed for transmission to Naval Forces, it is entitled NAV NBC 3 NUC, and is referred to as a *Naval Effective Downwind Message*, or NAV EDM. These messages provide positions in geographical coordinates, angular measurements in degrees true, distances in nautical miles, and speeds in knots. The NAV NBC 3 NUC report



NAV NBC 3 NUC	NBC 3 NUC	Description of Elements
A. 24 D. 201405Z F. 5600N 01115E N. 10 KT Y. 01000140 DEGREES Z. 01000804 NNNN	A. 24 D. 201405Z F. 32VLB 126456 N. 10 KT Y. GRID 17782489 MILS Z. 01901508 NNNN	A. Strike serial number. D. Date-time of strike. F. Coordinates of blast. N. Weapon yield. Y. Clockwise direction of left fallout radial (4 digits), then the right fallout radial (4 digits). Z. Effective downwind speed (3 digits), Zone 1 downwind distance (3 digits), and the cloud radius (2 digits).
<p><b>NOTE:</b> When the wind speed is less than 8 KPH (5 knots), the Zone I downwind distance in element 'Z' will be reported in only 3 digits, which is the radius of the Zone I hazard from GZ.</p>		

Figure 5-4.—Example of the contents of NATO reports NAV NBC 3 NUC and NBC 3 NUC effective downwind messages.

also contains evaluated information on the detonation, including weapon yield, effective fallout direction and speed, and cloud radius.

An NBC 3 NUC message of effective fallout downwind speed and direction for ground forces is called an *Effective Downwind Message*. In this message, locations are given in UTM coordinates, angular measurements in degrees or mils, distances in kilometers, and speeds in kilometers per hour. See figure 5-4.

### PLOTTING RADIOLOGICAL FALLOUT AREAS

In the ATP-45, nuclear fallout is grouped into three categories:

- Immediate fallout—heavy debris deposited near ground zero within 1/2 hour of the blast.
- Medium Range fallout—debris deposited from 1/2 hour to 20 hours after a blast, up to hundreds of miles from ground zero.
- Long Range fallout—very light particles that remain suspended in the atmosphere from 20 hours to several years. Fallout is deposited over a very large area of the earth's surface.

The NATO Nuclear fallout warning areas discussed in this chapter show only the areas that receive immediate and medium range fallout. The hazard to people in contaminated areas depends on the concentration of fallout, the amount of time the person has been in the contaminated area, and the total radiation the person has been exposed to over a period

of time. Contaminated areas will remain radioactive for a considerable period of time on land, but the contamination is dispersed rapidly over water areas.

The quantity of fallout released by a blast is directly proportional to the size of the blast—a low-yield blast produces less fallout than a high-yield blast, and by the height of the blast. A high-air burst produces very little fallout, a low air-burst produces some fallout, and a surface-burst produces great amounts of fallout. At sea, a subsurface burst produces less fallout as the depth increases, with negligible fallout if the fireball does not break the surface. The effects of a nuclear blast are discussed in detail in your *Basic Military Requirements* course, as well as in *Military Requirements for Petty Officer Third Class*.

Figure 5-5 Shows a typical NATO fallout plot. The + marks the point where the weapon will be or has been detonated, identified by the letters GZ for *ground zero*.

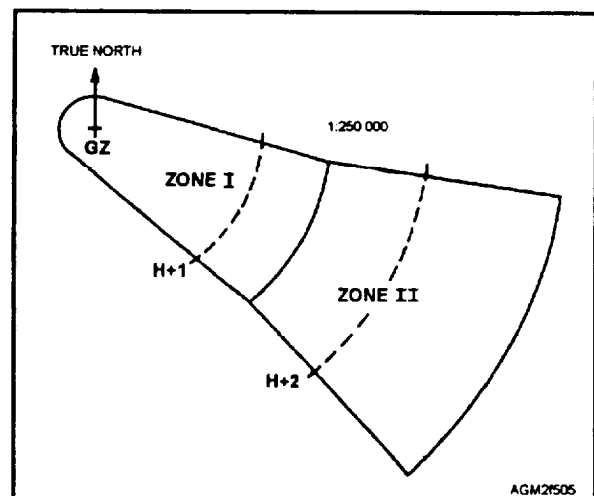

Figure 5-5.—NATO fallout plot.

The area marked *Zone I* is the Zone of Immediate Operational Concern. In this area, exposed, unprotected personnel will receive the maximum allowable emergency risk dose of 150 centigrays (rads) of radiation in a time period from 0 to less than 4 hours after the arrival of fallout. The 4-hour figure is an estimate of how long it would take to pack up essential ground force military units (equipment and personnel) and evacuate an area as an intact and effective fighting force. Essentially, Zone I must be evacuated before a strike occurs, or the military units in the areas will suffer high personnel casualties and extensive loss of equipment and supplies.

The area marked as *Zone II* is the Zone of Secondary Hazard. Exposed, unprotected personnel may operate in this area between 4 hours and 24 hours after the arrival of fallout before receiving 150 centigrays (cGy) of radiation. Essentially, military units in this area have the necessary time to pack up and evacuate after the arrival of fallout and remain effective as a fighting force.

Outside of Zone I and Zone II, some fallout will be received. However, military units may continue operating for up to 24 hours and be expected to receive less than 50 cGy radiation, and to operate for indefinite periods of time without receiving more than 150 cGy radiation.

To construct a NATO fallout diagram, follow these steps:

1. Locate ground zero (GZ) and mark it on your chart.
2. Draw the radial lines. Using information in a NAV NBC 3 NUC or NBC 3 NUC message, draw a straight line extending from GZ toward the directions indicated for the left and right radial lines. These directions are measured clockwise from true north when measurements are in degrees, or clockwise from grid north when measurements are in mils.

### OR

Using information in the TESS RADFO output or an Effective Downwind Forecast, plot a line extending from GZ representing the Effective Downwind Direction. Then, plot the radial lines extending from GZ at 20° or one-half of the expansion angle right and left of the EDD line.

3. Draw the cloud radius. From the NBC 3 NUC or TESS output, determine the cloud radius. When using an Effective Downwind Forecast, obtain a representative cloud radius for the appropriate yield group from

the table provided on the Ship's Fallout Template (fig. 5-6). Use a compass to set the radius on your chart's latitude scale (1 minute of latitude is 1 nautical mile) or grid scale, and draw the circle around ground zero.

4. Draw the Zone I boundary. TESS output: Set your compass to the *Distance to Zone I* using the latitude scale. NBC 3 NUC message: Set your compass to the Effective Downwind Distance, also using the latitude scale. Effective Downwind Forecast: Use the nomogram shown in figure 5-7, the actual weapon yield (or the maximum weapon yield if plotting a yield group for planning purposes) and the effective downwind speed provided by the forecast to calculate the Zone I downwind distance. Set the compass to this distance. With the compass point at GZ, draw an arc extending between the left- and right-radial lines. Use a straightedge to draw lines tangent to the cloud radius circle and the point of intersection of the radial lines and the Zone I boundary arc. Label the entire area within the cloud radius circle, the two tangent lines, and the Zone I arc as *ZONE I*.

5. Draw the Zone II boundary. Double the Zone I downwind distance, and draw a second arc between the radial lines. Label the area enclosed between the radial lines and the Zone I and Zone II boundaries as *ZONE II*.

6. Draw the fallout arrival time arcs. The Effective Downwind Speed is the distance traveled by the fallout in 1 hour. Set your compass to the appropriate distance, place the compass point at GZ, and draw a dashed-line arc over the fallout plot. Label this line as *H+1*, for the arrival of fallout 1 hour after detonation. Double the distance on the compass and draw a second arc across the diagram. Label the second arc as *H+2*. Higher yield weapons may need an *H+3* arc. The effective downwind speed can also be determined by using the nomogram shown in figure 5-7.

7. When the effective downwind speed is less than 8 KPH (5 knots), the predicted fallout areas of Zone I and Zone II will be drawn circular around ground zero.

8. Finally, label the plot with the weapon yield, the date-time of the attack (or the valid period of the Effective Downwind Forecast), the location coordinates or name of the location, and the effective downwind speed and the UTC time (observation time of the upper winds used in the fallout prediction).

The NATO fallout plot (for any scale chart) can also be constructed by using the Ship's Fallout Template (fig. 5-6) or the three Land Fallout Templates that come with the ATP-45. The templates are transparent plastic diagrams with perforated holes used to place guide

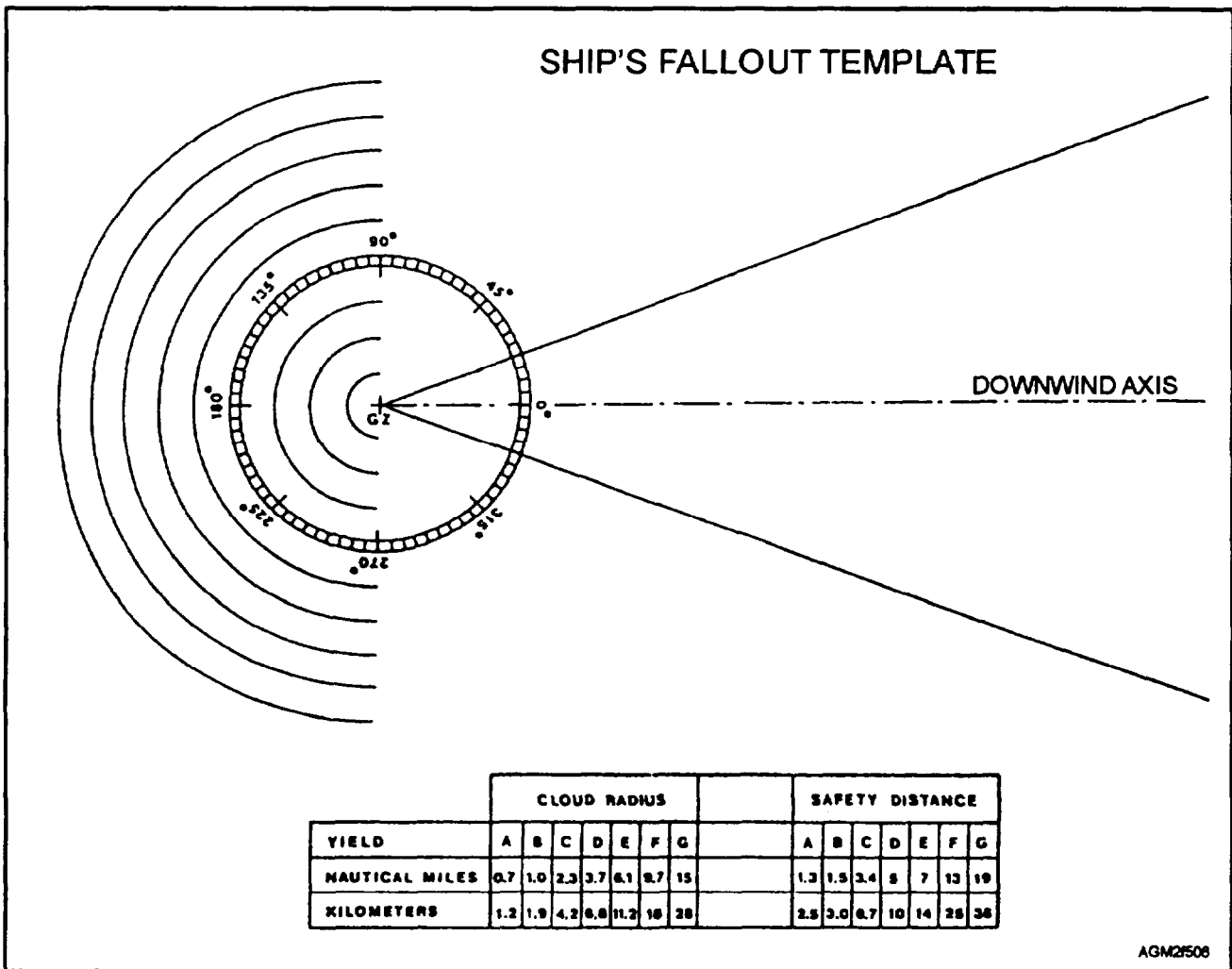

Figure 5-6.—Ship's fallout template—a clear plastic template used to plot fallout diagrams on any scale chart.

marks on the underlying chart. Unlike the Land Fallout Templates, the semicircles upwind of GZ on the Ship's Fallout Template do not refer to specific weapon yields, but only serve as an aid in plotting. The 20° radial lines to the left and right of the downwind axis are not provided with units of measurement. In addition, since geographical charts used at sea are not uniformly scaled, the Ship's Fallout Template is unscaled. To use the Ship's Fallout Template, follow the steps outlined below.

1. Draw Grid North (downwind direction for appropriate weapon yield from NAV EDM) on the template from ground zero. Grid North is determined from a NAV NBC 3 NUC message by averaging the left and right radials from element "Y" of the message.

2. Plot the downwind distance to Zone I from element "Z" of the message or use the nomogram (fig. 5-7) to determine the downwind distance to Zone I.

Double the distance to determine Zone II. Draw two arcs between the radial lines.

3. Determine the cloud radius from the Ship's Fallout Template using the appropriate yield group from the NAV EDM. Element "Z" of a NAV NBC 3 NUC message will contain more accurate cloud radius data.

4. From the intersections of the Zone I arc with the radial lines, draw two more lines to connect the cloud radius circle.

5. To determine the area where deposition of fallout is estimated to take place at a specific time, simply multiply the effective downwind speed by the time (in hours). Draw an arc between the two radial lines at the distance calculated. For example: 10 knots x 1.25 hours is 12.5 NM.

6. Add and subtract the safety distance as determined from the Ship's Fallout Template for the

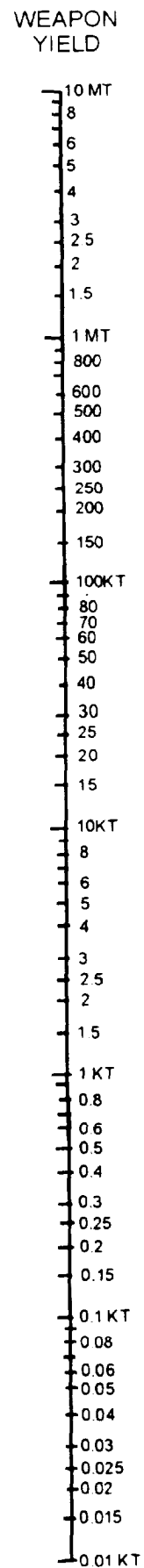
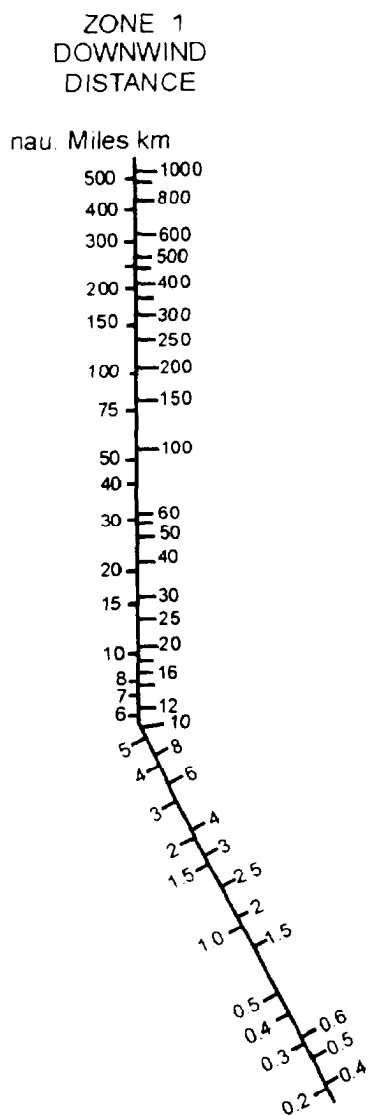
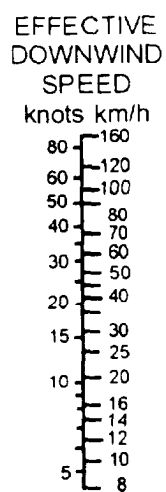

DETERMINATION OF  
ZONE 1

AGM2f507

Figure 5-7.—Zone I downwind distance nomogram, used to calculate downwind distance from the effective downwind speed and weapon yield provided in an effective downwind forecast.

appropriate weapon yield, and draw two additional arcs across the fallout pattern. This is the area where fallout will be most heavily deposited.

7. When the effective downwind speed is less than 8 KPH (5 knots), the predicted fallout areas of Zone I and Zone II will be drawn circular around ground zero.

8. Complete the fallout plot by indicating the date-time of the message used, the yield and date-time of burst, ground zero position, and scale of chart used.

Figure 5-8 is an example of a completed fallout plot using the Ship's Fallout Template.

### REVIEW QUESTIONS

- Q6. What are the two types of radiological fallout messages of most concern to Aerographers?
- Q7. What factors determine the extent and severity of a fallout contamination hazard area?
- Q8. What type of nuclear burst produces the most fallout?
- Q9. How are personnel operating in a NBC hazard Zone II affected by radiation?

- Q10. What is the average cloud radius (NM) of a nuclear weapon in yield group "BRAVO"?
- Q11. How is fallout arrival time determined?
- Q12. Why is the Ship's Fallout Template unscaled?
- Q13. What information is contained in section "Z" of a NAV NBC 3 NUC message?
- Q14. What is the safety distance (NM) for a 3.5 kiloton weapon?
- Q15. When the effective downwind speed is less than 5 knots, how are nuclear fallout patterns plotted for hazard zones I and II?

### PLOTTING CHEMICAL CONTAMINATION

**LEARNING OBJECTIVES:** Define terms associated with chemical warfare. Interpret the information provided in a NATO chemical downwind message (CDM). Plot the attack and hazard area for the three basic chemical contamination situations.

### SHIP'S FALLOUT TEMPLATE

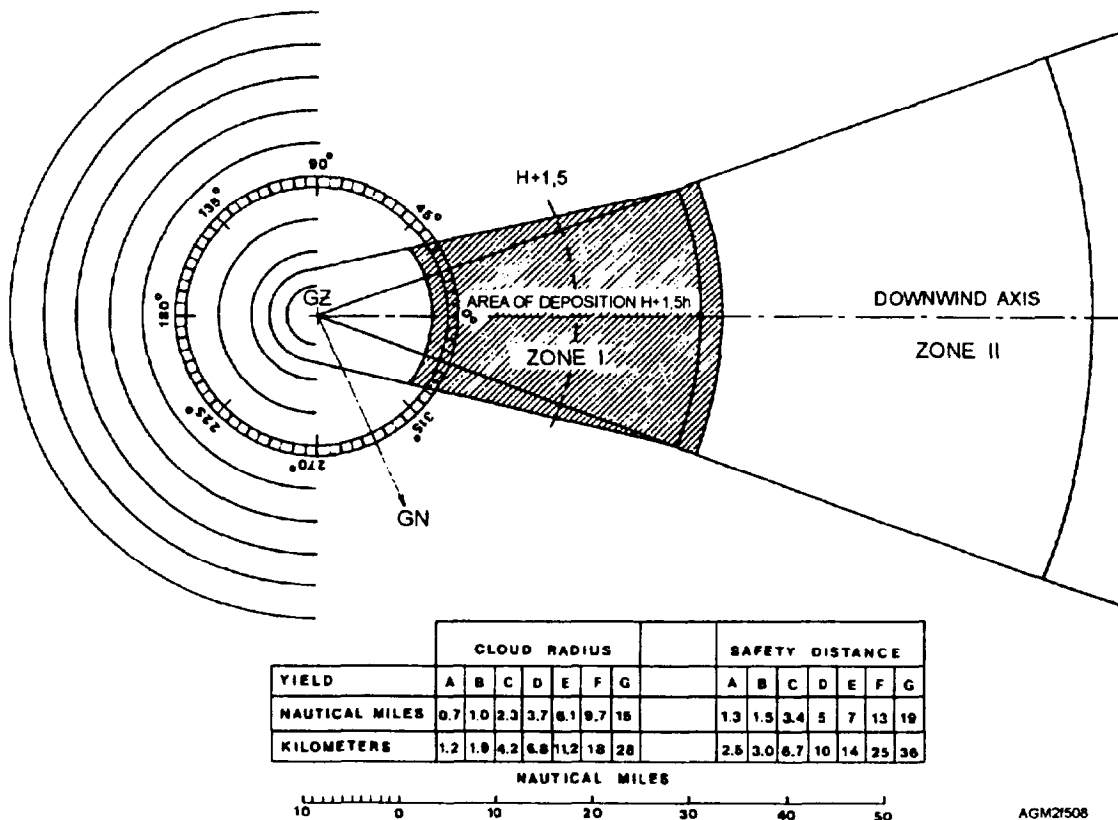

Figure 5-8.—Example of fallout plot using ship's fallout template.

Unlike nuclear fallout, the dispersal of chemical contamination is normally confined to a far smaller area, with much of the effects of the chemical depending on the local weather conditions. Considering the limited area effected by chemical weapons, any plot of chemical contamination is normally done only on the smaller scale charts, such as 1:50,000.

In amphibious battle situations supported by U.S. Naval ships and Marine Corps forces, you must prepare for the possibility that the opposing force will employ chemical weapons either against the ships or against the ground forces supported by your ship. The attack may come from bombs, rockets, or aerial spray. Accurate calculations for the area contaminated by the chemical agent are only possible after the agent has been identified. These calculations are preformed by forecasters or NBC evaluators following procedures detailed in ATP-45. Evaluated information is passed as a message following the NBC 3 CHEM format. As a Aerographer, you should be able to interpret a *NAV NBC 3 CHEM* or an *NBC 3 CHEM* report—the *Chemical Downwind Message*, and to plot the possible contamination area reported in the message.

Later, as you study to become a forecaster, you will learn about the format of a Chemical Downwind Forecast (CDF)—a product of basic forecast meteorological parameters used to evaluate how far downwind a particular chemical agent remains hazardous. CDFs are normally used by non-meteorological personnel at NBC centers to evaluate the duration and extent of chemical contamination for a specific chemical agent.

## CHEMICAL WARFARE TERMS

Chemical agents may be spread by many means, such as bombs, mortar shells, artillery shells, rockets, missiles, mines, generator fog, or aircraft spray. The area where the chemical agent is released is called the *attack area*. The attack area includes a minimum radius of 1/2 nautical milc (at sea) or 1 kilometer (ashore) around the release site. This area is considered to be immediately contaminated because of the explosives distributing the agent or by the initial chemical spray.

Chemical agents are spread outward from the attack area by diffusion through the air and by mixing caused by the winds. The area contaminated by airborne chemical agents outside the attack area is called the *hazard area*. In situations involving calm or light winds (5 knots or less), the contamination is considered to spread outward from the attack area in all directions.

When the winds are greater than 5 knots, describing the hazard area is not as simple. Generally, the hazard area will form a triangular pattern. The contamination on the upwind side of the attack area is prevented because the contamination is carried with the wind toward the downwind side of the attack area. The information needed to describe the triangular pattern and the orientation of the hazard triangle is the chemical downwind direction, the downwind hazard distance, and the radial angles.

The direction the contamination is carried by the wind is called the *chemical downwind direction* (CDD). The CDD is 180 degrees opposite the surface-wind direction.

The distance the contamination is carried by the wind, outside the attack area, in high enough concentration to cause casualties, is called the *downwind hazard distance* (DHD), as shown in figure 5-9. The DHD depends on the type of agent, the means of delivery, the terrain, and the effects of the meteorological elements on the agent. The DHD is a minimum of 5 nautical miles (10 kilometers) and may extend up to 27 nautical miles (50 kilometers) from the center of the attack area.

Radials extend tangent from the edge of the attack area 30 degrees either side of the CDD ashore. At sea, 35° radial angles are used when the winds are between 5 and 10 knots, but only 20° radial angles are used when the winds are 10 knots or greater. The angles used to draw the radials account for variations in wind direction and horizontal diffusion of the chemical agent. These angles are referred to as *half-sector angles* (HSA).

The *chemical down windspeed* (CDS) is considered the same as the prevailing surface wind speed. However, calculations involving the time the leading edge of a chemical cloud arrives at a specific downwind location use a maximum speed of the CDS multiplied by 1.5 in order to account for variability in wind speed or gusty conditions.

One basic characteristic of a chemical agent that must be considered is the persistency of the agent—the tendency of the agent to vaporize to form a hazardous gas. *Non-persistent* (NP) *agents* are generally hazardous gases that remain in the target area for minutes or, in exceptional cases, for several hours after the attack. *Persistent* (P) *agents* are generally hazardous liquids which usually emit a hazardous vapor that remains in the target area for hours or days or, in exceptional cases, weeks after the attack.

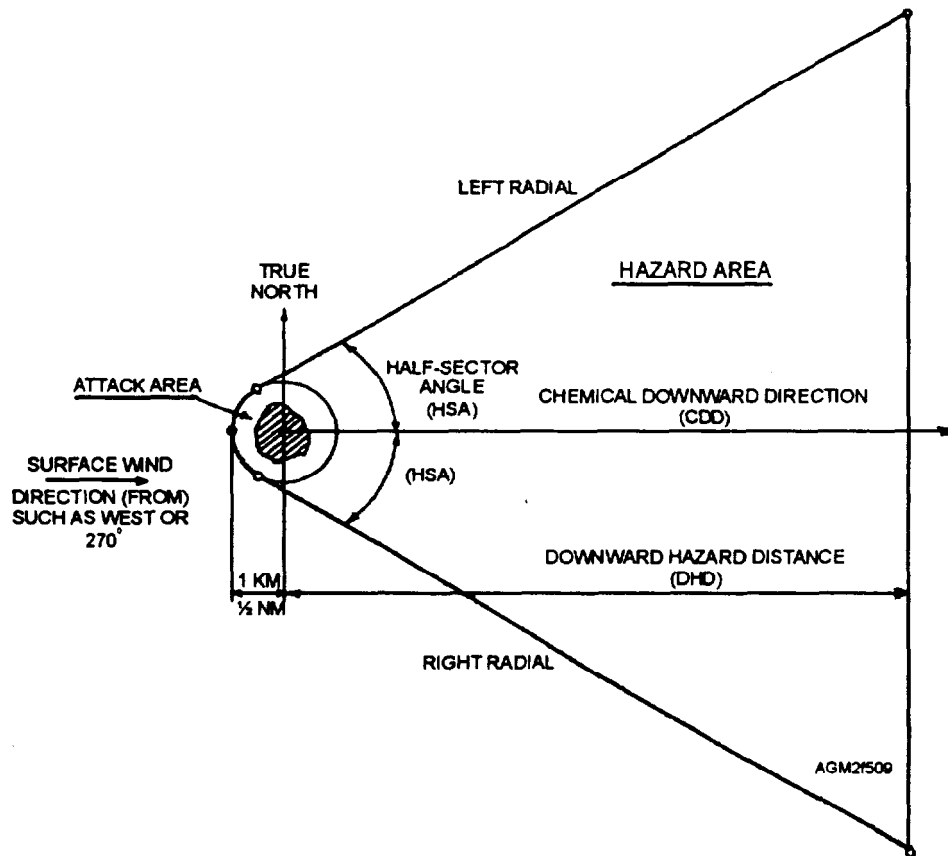

Figure 5-9.—Chemical contamination carried by the wind.

Some chemical agents are designed to contaminate the air and to cause disabling or lethal casualties when the vapor is breathed or contacts the skin or eyes. These are called *air-contaminating agents*. Air-contaminating agents generally form a gas cloud that moves with the wind currents. However, some chemical agents readily diffuse through the air and spread out from an attack area *even* in calm winds. Air-contaminating agents may be classified as either persistent or non-persistent. When an unknown type of chemical agent is used, it is always considered an air-contaminating agent until otherwise identified.

Other chemical agents (a solid or liquid) may be spread over an attack area to contaminate the ground and other surfaces. To some extent, the solids or liquids emit a hazardous vapor. Direct contact or close proximity to the contamination may cause disabling or lethal casualties. These types of agents are known as *ground-contaminating agents*. The normal downwind hazard distance of any ground contaminating agent used at sea is assumed to be 10 nautical miles.

Various chemical agents are known to be ready for use by countries that do not accept or ignore the Geneva Conventions agreement prohibiting the use of chemical weapons. After a chemical agent has been used in the

field, the chemical may be classified by *agent groups* based on the effects of the agent on the human body. Agent groups include nerve, blister, blood, choking, incapacitating, irritant, and vomiting. Survey teams may perform tests to determine the composition of an agent. After testing, the agent may be identified by name, such as Tabun, Sarin, Soman, Mustard, or Lewisite. NBC protection, varying from use of gas masks to wearing complete NBC suits, depends on the agent group and specific agent employed. Further information on chemical agents and protection is contained in the *Military Requirements for Petty Officer Third Class* training manual.

When a suspected chemical weapon is employed against your location or ship, you first must complete personal and shipboard protective procedures. As the weather observer, you must then report current meteorological conditions to your shipboard Combat Information Center, or ashore, to Base Operations or the local NBC center.

Weather conditions that are required for the evaluation of the chemical agent downwind hazard distance (DHD) and the duration of the hazard are as follows:

- Wind direction and speed (degrees true and knots)
- Current air temperature and daily mean surface air temperature (°C)
- Relative humidity
- Total cloud cover (clear, scattered, broken, or overcast)
- Air stability (ashore)
- Air-sea temperature difference or sea-surface temperature (sea)
- Presence and type of any precipitation
- Presence of any temperature-inversion layers aloft with a base less than 1,500 feet

The elevation angle of the sun above the horizon is also an important value you may be asked to provide. However, the Quartermasters on the bridge may be able to determine this value faster and more accurately by measurement with a sextant.

Ashore, the air stability is determined by a *near surface temperature gradient*—difference between the surface air temperature and the air temperature at 100 meters (330 feet) AGL. The stability should be determined by your forecaster, as should the presence of temperature inversion layers aloft. The evaluated stability that the NBC evaluator needs is a statement of “stable” (any temperature increase or a decrease  $<1^{\circ}\text{C}$  from surface to 100 meters), “neutral” ( $1^{\circ}\text{C}$  decrease from surface to 100 meters), or “unstable” ( $>1^{\circ}\text{C}$  decrease in the first 100 meters). As for elevated temperature inversions, the evaluator only needs to know if an elevated inversion is present below 1,500 feet.

At sea, a slightly different evaluation procedure is used. The difference between the air temperature and the sea-surface temperature (not necessarily the seawater injection temperature) is used by the evaluator, along with the wind speed, to determine stability. The value required is  $T_{\text{air}} - T_{\text{sea surface}}$ . Negative values generally indicate unstable conditions, values near zero indicate neutral conditions, and positive values indicate stable conditions. Since this value is critical, the evaluator may request the sea-surface temperature, instead of or in addition to the air-sea temperature difference, to perform or check the calculation.

As long as your ship or unit remains in or near a hazard area, you must also monitor the winds. You must immediately report any significant changes in

wind speed or direction to the forecaster or NBC evaluator. Significant changes include the following:

- Any change in the 2-minute wind speed of 5 knots or greater.
- Any change in the 2-minute wind speed decreasing to less than or increasing to more than 5 knots.
- Any change in the 2-minute wind direction of more than 20 degrees.
- Any change in the stability category, that is from stable to unstable or vice versa.

At sea or ashore, your activity may be tasked to maintain a chart of chemically contaminated areas. Unlike a standard weather chart, a single chart is used. It is updated by plotting new attack and hazard areas as attacks occur and by erasing or deleting old hazard areas or attack areas as the contamination decreases to safe levels. The duration of the hazardous contamination may be different within the attack area and the hazard area. This information, along with other critical evaluated information, may be provided by your forecaster or received from an NBC evaluation center as a chemical downwind message.

## REVIEW QUESTIONS

- Q16. What is the minimum radius of a chemical warfare attack area from ground zero?
- Q17. What is meant by the term “DHD”?
- Q18. Given a wind speed of 16 knots, what would be the approximate downwind speed of the leading edge of the chemical cloud?
- Q19. What is the assumed downwind hazard distance of a ground contaminating agent used against Naval Forces?
- Q20. What meteorological parameters are required for a chemical hazard evaluation?
- Q21. What would an air/sea temperature stability value of -5 indicate?

## CHEMICAL DOWNWIND MESSAGE

The NBC 3 CHEM message, known as a *chemical downwind message*, is used to report evaluated information on the chemical agent employed in an attack and the area contaminated ashore (fig. 5-10). A NAV NBC 3 CHEM message is used to report similar information to Naval Forces.



NBC 3 CHEM	NAV NBC 3 CHEM	EXPLANATION
<p>A. 002</p> <p>D. 010903Z</p> <p>F. 32V UC250010 UTM ACTUAL</p> <p>G. MISSILE</p> <p>H. NERVE, P, GROUND BURST</p> <p>PA. UC248020 UC240015 UC240005 UC300900 UC370020 UTM</p> <p>PB. ATTACK AREA 2-4 DAYS HAZARD AREA 1-2 DAYS</p> <p>Y. 0120 DEG AT 008 KMH</p> <p>ZA. 315962</p> <p>ZB. TYPE BRAVO, CASE ALPHA MAX DHD 010 KM</p>	<p>A. 002</p> <p>D. 010903Z</p> <p>F. 240005N 0961321W DMS ACTUAL</p> <p>G. MISSILE</p> <p>H. NERVE, NP, 200 FT</p> <p>PA. 240105N 0961321W, TO 234005N 0955721W, TO 234005N 0962921W DMS</p> <p>PB. ATTACK AREA 1 DAY HAZARD AREA 1 DAY</p> <p>Y. 0360 DEG 12 KNOTS</p> <p>ZA. 315962</p> <p>ZB. TYPE ALPHA CASE B MAX DHD 20 NM HSA 35 DEG</p>	<p>A: Strike serial number (optional).</p> <p>D: UTC date-time of attack.</p> <p>F: Location of attack, estimated or actual.</p> <p>G: Type of attack (aircraft. bomb, missile etc.)</p> <p>H: Type of agent, persistent (P) or Non-persistent (NP), and height of burst.</p> <p>PA: Hazard area (military grid) or coordinates of outline of hazard area.</p> <p>PB: Duration of hazard in days.</p> <p>Y: Chemical downwind direction (4 digits in degrees or mils) and wind speed (kmh or knots).</p> <p>ZA: Weather conditions used in evaluation of conditions in format <i>bTTUwn</i></p> <p>ZB: Type and case of chemical attack, max DHD, and HSA.</p>
<p><b>ZA. WEATHER CONDITION CODES in format <i>bTTUwn</i>:</b></p> <p><i>b</i> is the air stability code:</p> <ul style="list-style-type: none"> <li>1 = very unstable</li> <li>2 = unstable</li> <li>3 = slightly unstable</li> <li>4 = neutral</li> <li>5 = slightly stable</li> <li>6 = stable</li> <li>7 = very stable</li> </ul> <p><i>TT</i> is the air temperature in whole °C. Add 50 to negative temperatures. (-10°C = 60)</p> <p><i>U</i> is the tens-value of the relative humidity.</p> <p><i>w</i> is the significant weather code:</p> <ul style="list-style-type: none"> <li>0 for no significant weather,</li> <li>3 for blowing snow, sand, or dust,</li> <li>4 for haze or fog (vsby &lt;4,000 meters),</li> <li>5 for drizzle,</li> <li>6 for rain,</li> <li>7 for snow or mixed snow/rain,</li> <li>8 for showers (rain, snow, or mixed),</li> <li>9 for thunderstorms, with or without precip,</li> <li>S for elevated inversion layer.</li> </ul> <p><i>n</i> is the cloud coverage:</p> <ul style="list-style-type: none"> <li>0 for clear, scattered or few.</li> <li>1 for broken.</li> <li>2 for overcast.</li> </ul>		
<p><b>ZB. ATTACK TYPES AND CASES:</b></p> <p>Type A: Air contaminating Agent</p> <ul style="list-style-type: none"> <li>Case a: Winds 5 knots (10 KM/H) or less.</li> <li>Case b: Winds more than 5 knots (10 KM/H).</li> </ul> <p>Type B: Ground Contaminating Agent.</p> <ul style="list-style-type: none"> <li>Case a: Contamination within 1/2 nm radius circle.</li> <li>Case b: Contamination covers area radius between 1/2 nm and 1 nm.</li> <li>Case c: Contamination covers area greater than 1 nm in any direction.</li> </ul>		

Figure 5-10.—Chemical downwind message. Contents and explanation of an NBC 3 CHEM (ground forces) and in NAV NBC 3 CHEM (Naval Forces).

## PLOTTING CHEMICAL CONTAMINATION DATA

Plotting chemical contamination areas is easy once you understand the terms and the contents of a chemical downwind message. Normally, the military grid squares contaminated by a chemical weapon are provided in element PAPA-ALFA of the chemical downwind message. In a NAV NBC 3 CHEM message, the contaminated area boundary positions should be provided in degrees, minutes, and seconds (DMS). A better picture of the contaminated area is constructed using other parameters contained in the message. From the NAV NBC 3 CHEM message, check element ZULU-BRAVO to determine the type and case of the attack. Element ZULU-ALFA contains environmental information, and, on occasion, plain language may be used in lieu of the meteorological reporting code. Now let's discuss the methods used to plot initial

contamination for circular, triangular, and double-triangular hazard areas.

### Circular Hazard Area

When winds are 5 knots or less in a type A-case (a) or a type B-case (a), case (b), or case (c) attack, the attack area is plotted as a circular hazard area. The important factor is that the prevailing wind speed is 5 knots or less. In both type A-case (a) and type B-case (a) attacks, the attack area is drawn as a 1/2-nautical-mile-radius (1-kilometer-radius) circle around the location where the chemical agent was deployed. In a type B-case (b.) attack, the attack area is drawn as a 1/2- to 1-nautical-mile-radius circle centered on the attack site and in a type B-case (c), the attack area is drawn larger than a 1-nautical-mile radius, depending on the type of attack. In all of these situations, the hazard area is a 10-kilometer-radius circle around the attack area for

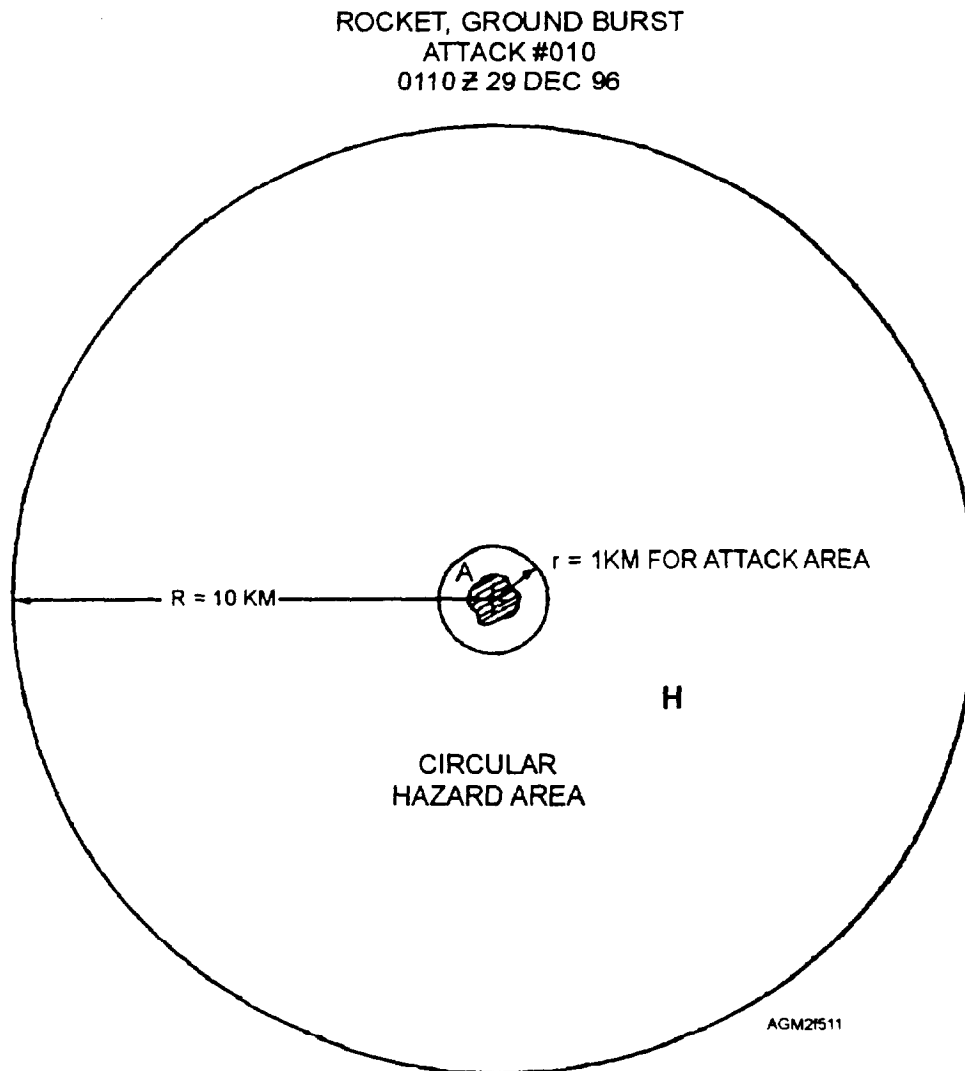

Figure 5-11.—Circular hazard area. Plotted type B-case (a) chemical attack, land. Wind speed 10 KPH/5 kt or less.

ground forces, and a maximum of 15-nautical-mile radius for Naval Forces.

From the NAV NBC 3 CHEM message, element FOXTROT, locate and mark the attack coordinates on your chart. Using a compass, set the distance between the points to 30 seconds of latitude (1/2 nautical mile), and draw a circle of this radius around the detonation point. Label the area within this circle "A," for the *attack area*. Then set the compass spacing to 15 minutes of latitude, and draw a second circle with that radius around the detonation point. Label the area within this circle as "H," for the *hazard area*. Near the circle, you should note the attack serial number and the date-time of the attack. The NAV NBC 3 CHEM message should either be kept with the chart or all of the other information should be noted on the chart (fig. 5-11).

### Triangular Hazard Area

When the winds are greater than 5 knots in a type A-case (b) or type B-case (a) or case(b) attack, the plotted hazard area will generally be a triangular pattern with a circular attack area at the apex. The area is plotted as follows:

1. From the NAV NBC 3 CHEM message, locate the detonation point and mark this on your chart.

2. Now draw a light line through the point in the direction given by the chemical downwind direction (element YOKE). The line should extend through the **point** for just over 1 nautical mile in the upwind direction and up to 27 nautical miles in the downwind direction, as long as the downwind hazard distance (DHD).

3. From element ZEBRA-BRAVO, obtain the DHD. Measure the DHD from the center of the detonation downwind on the CDD line, and mark the distance on the line.

4. Now use a compass to draw a 1/2 nautical mile radius circle around the detonation point for either a type A, case (b) or a type B, case (a) attack, or a 1 nautical mile radius circle for a type B, case (b) attack. Label the area within the circle "A," for *attack area*.

5. From element ZEBRA-BRAVO, determine the half-sector angle (HSA). If not given, the HSA is 30 degrees. Using a protractor on the segment of the CDD line on the upwind side of the detonation point, and the HSA angle, draw two radial lines tangent to the attack area boundary circle: one at the HSA angle to the left of the CDD line, the second at the HSA angle to the right of the CDD line (fig. 5-12).

6. Now draw a line perpendicular to the CDD line at the downwind hazard distance (DHD) marked earlier.

7. Label the triangular area extending downwind from the attack area as "H," for *hazard area*.

8. Transfer all information from the NAV NBC 3 CHEM message to the chart.

**NOTE:** Instead of using a protractor to measure the HSA angles, you may construct a reusable template with 20-, 30-, and 35-degree HSA angles. Instructions for construction and use of the template are provided in the ATP-45.

### Double-Triangular Hazard Area

When chemical contamination is dispersed over an elongated area, such as would occur during an aircraft spray attack, the resulting hazard area is plotted as two connected triangular areas. In the case of an aerial spray attack, it is assumed that the width of attack area is greater than 2 kilometers (1 nautical mile) wide. Normally, only ground-contaminating agents are used with an aerial spray. Once the agent settles on the ground, the vapor released by the liquid or solid agent drifts downwind. This hazard area is normally associated with a type B-case (c) chemical attack.

When the attack location is provided as a series of coordinates in element FOXTROT, or two coordinates

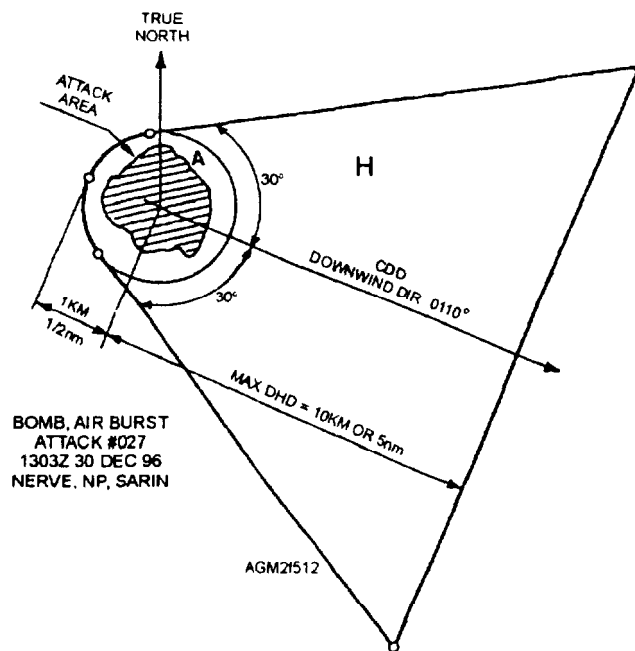

Figure 5-12.—Triangular hazard area. Plotted type A-case (b) chemical attack.

with a "to" or "through" statement (such as "point A to point B"), plot the attack area as follows:

- Draw  $\frac{1}{2}$ -nautical-mile-radius circles at both the beginning and end points in a spray line. Regard the two circles as being two separate attack areas.

- Draw two tangent lines connecting the circles (one upwind and one downwind).

As shown in figure 5-13, the hazard area is plotted by drawing a line representing the chemical downwind direction from the center of both circles, representing the beginning and ending points of the attack. Mark the DHD on each CDD line. Usually, the DHD for a ground-contaminating agent is 10 nautical miles; however, check element ZEBRA-BRAVO and use the DHD provided. Draw two radial lines tangent to each circle using the half-sector angle given in the message (or  $30^\circ$ ). Draw lines perpendicular to the CDD lines at the marked DHD to form two triangular areas. Connect the apexes of the two resulting triangular hazard areas between points A and B, as shown to complete the hazard area.

The three situations we have discussed represent the basic plots of different hazard areas that could result from a chemical attack. Changes in wind speed and/or wind direction may require a reevaluation of the hazard area boundaries. Reevaluation is normally done by the forecaster or the personnel in the NBC center, and a supplemental NAV NBC 3 CHEM message is normally transmitted to cover the new areas. When a reevaluated NBC message is received with the same attack serial number and date-time of the attack message that has already been plotted, you should plot the new boundaries over the old hazard boundaries, possibly in a different color, and note the new information alongside the plot.

### REVIEW QUESTIONS

- Q22. What are the two types of chemical hazard messages of most concern to Aerographers?
- Q23. What information is contained in element "PA" of an NBC 3 CHEM message?
- Q24. What information is contained in element "ZB" of a NAV NBC 3 CHEM message?
- Q25. What would the code "217981" indicate in element "ZA" of a NAV NBC 3 CHEM message?

- Q26. How should a chemical hazard area be plotted for a Type "A" attack when the average wind speed is 5 knots or less?
- Q27. What information must be obtained from an NBC 3 CHEM message in order to plot a triangular chemical hazard area?
- Q28. When is a double triangular chemical hazard area plotted?

### SUMMARY

There are several different types of messages related to NBC warfare. Various graphic products can be completed from these messages for NBC planning and briefing purposes. Most of these products can be rapidly produced from TESS. In this chapter, we have discussed the terms used to describe various aspects of NBC warfare and discussed in detail the elements of NBC messages you are most likely to encounter. We also described the manual methods for producing NBC hazard prediction plots.

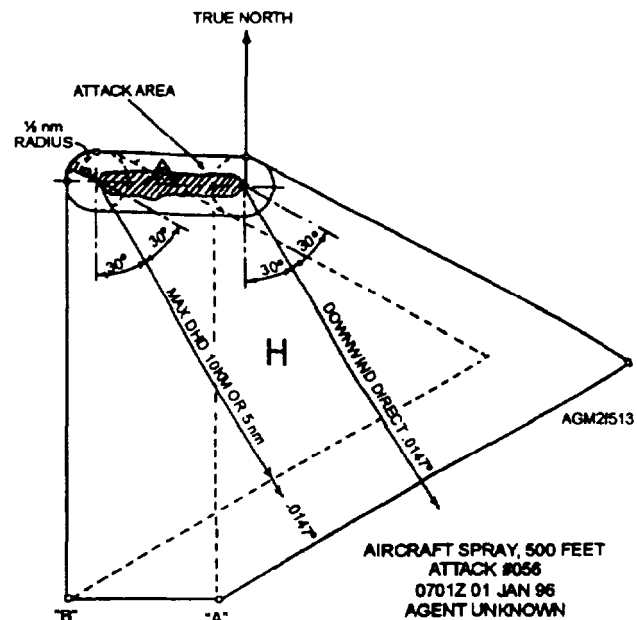

Figure 5-13.—Double-triangular hazard area. Plotted type B-case (c) chemical attack.

# ANSWERS TO REVIEW QUESTIONS

- A1. *Nuclear, biological, and chemical warfare.*
- A2. *Allied Tactical Publication (ATP) 45. Reporting Nuclear Detonations. Biological and Chemical Attacks, and Predicting and Warning of Associated Hazards and Hazard Areas.*
- A3. *There are six types of NBC messages. Ground forces report information using grid coordinates, distances in kilometers, and wind speeds in KPH while Naval Forces use geographical coordinates, distances in nautical miles, and wind speeds in knots.*
- A4. *An EDF is an Effective Downwind Forecast used for planning purposes. An EDM is an Effective Downwind Message that is transmitted after an actual nuclear detonation, providing more specific fallout prediction areas.*
- A5. *The wind direction, downwind speed, and the expansion angle for nuclear weapons of more than 30 kilotons and up to 100 kilotons.*
- A6. *NBC 3 NUC, an effective downwind message for ground forces and a NAV NBC 3 NUC, an effective downwind message for Naval Forces.*
- A7. *The amount of fallout depends on the weapon yield and the type of burst. The amount of personal contamination depends on the concentration of the fallout, the amount of time the person has been in the contaminated area, and the total radiation the person has been exposed to over a period of time.*
- A8. *A surface burst.*
- A9. *Exposed, unprotected personnel may operate in hazard Zone II between 4 and 24 hours after the arrival of fallout before receiving dangerous dosages of radiation.*
- A10. *1 nautical mile.*
- A11. *The effective downwind speed is the distance traveled by the fallout in 1 hour. It may be calculated for any specific time and distance using the estimated wind speed.*
- A12. *The Ship's Fallout Template is unscaled since geographical charts used at sea are not uniformly scaled.*
- A13. *Effective downwind speed (knots), downwind distance of Zone I (nautical miles), and cloud radius (nautical miles).*
- A14. *5 nautical miles.*
- A15. *Zone I and Zone II are drawn as circular patterns from GZ.*
- A16. *1 kilometer for ground forces and 1/2 nautical mile for Naval Forces.*

- A17. *DHD is the Downwind Hazard Distance- the distance the contamination hazard will travel dependent on the weapon type, method of delivery, terrain, and the meteorological conditions.*
- A18. *24 knots.*
- A19. *10 nautical miles.*
- A20. *Wind speed and direction, air temperature, mean daily surface temperature, relative humidity, total cloud cover, air stability/air-sea temperature difference, presence and type of precipitation, and the presence of temperature inversion layers.*
- A21. *Unstable conditions.*
- A22. *NBC 3 CHEM, chemical downwind message for ground forces and NAV NBC 3 CHEM, chemical downwind message for Naval Forces.*
- A23. *The hazard area (grid reference or geographical reference).*
- A24. *Type and case of chemical attack, maximum downwind hazard distance, and half sector angle.*
- A25. *Unstable air, temperature 17°C. relative humidity of between 90% and 99%. rain showers, and broken cloud cover.*
- A26. *In a circle, 1 kilometer (1/2 nautical mile) from ground zero for the attack area, and 10 kilometers from ground zero for the hazard area (ground forces) or 15 nautical miles (Naval Forces).*
- A27. *The location of the attack, the Chemical Downwind Direction (CDD), the Downwind Hazard Distance (DHD), and the Half Sector Angle (HSA).*
- A28. *In chemical spray attacks from aircraft when the hazard area will most likely be in an elongated pattern.*

## APPENDIX I

# GLOSSARY

### A

**ACCRETION**—Growth or increase in size by gradual addition.

**AGL**—Above ground level. Measurements suffixed by the abbreviation AGL refer to height.

**AMBIENT**—A representative reading or measurement for a substance under surrounding conditions.

**AMDAR**—Aircraft meteorological data relay.

**ANALOG**—Proportional and continuous. An analogue recorder draws continuous lines proportional to the electronic signal input. In an analogue signal, the sound pitch varies proportionately with the intensity of the signal, and the signal is continuous.

**ANEMOMETER**—A device used to measure wind speed and/or wind direction. From the Greek word anemo, meaning wind, and modern word meter, meaning measurement device.

**ANEROID**—Without fluid or without water. An aneroid barometer uses no fluid (mercury).

**ANOMALOUS**—Irregular or abnormal.

**APPARENT**—The way something appears or is perceived, although it may not be true.

**ASCENSION**—Rising or increasing in elevation.

**ASOS**—Automated surface observing system.

**AUTODIN**—Automatic digital network.

**AWN**—Automated weather network—the complex worldwide collection and distribution network of meteorological data and NOTAMs operated by the Air Force for the DoD.

**AZIMUTH**—The horizontal angular measurement from a fixed reference to a point. The Navy uses angular measurements in clockwise degrees from 0 to 360. When 0 is referenced to true north, the result is a true azimuth bearing. When referenced to an arbitrary direction, such as the bow of a ship, the result is a relative azimuth bearing.

### B

**BACKING**—A change in wind direction in a counter-clockwise manner in the Northern Hemisphere, or a clockwise direction in the Southern Hemisphere.

**BATHYMETRY**—The features and depths underwater.

**BATHYTHERMOGRAPH**—Any device used to measure and record temperatures through a column of water.

### C

**CAD**—Collective address designator.

**CDD**—Chemical downwind direction.

**CDS**—Chemical downwind speed.

**CENTIGRAYS**—(cGy) A measurement of absorbed radiation equal to 1 rad.

**CIC**—Combat information center aboard ship.

**CLIMATIC**—Any element associated with the climate of an area.

**CLIMATOLOGY**—The study of the statistical means, frequencies, deviations, and trends of weather elements for an area over a period of time.

**CODAR**—Coded aircraft report.

### D

**DDN**—Defense data network.

**DHD**—Downwind hazard distance (radiation or chemical).

**DIURNAL**—Any change that follows a daily pattern, completing one cycle on a daily basis.

**DME**—Distance measuring equipment, a radio aircraft navigation aid that provides only a distance to a DME transmitter site. Normally used in conjunction with VOR, ILS, or LOC equipment.

**DMS**—Position given in degrees, minutes, and seconds of latitude and longitude.

**DMSP**—Defense meteorological satellite program.

**DOWNWIND**—The direction towards which the wind is blowing; with the wind.

**DRIBU**—Drifting buoy.

**DROPSONDE**—A radiosonde instrument dropped by parachute from an aircraft.

**DSN**—Defense switched network, an upgrade and name change to the automatic voice network (AUTOVON).

**DUCT**—A layer in the atmosphere that readily traps electromagnetic energy permitting extended transmission ranges.

**DUCTING**—The process occurring within a duct, also known as trapping.

## E

**EDD**—Effective downwind direction (radioactive fallout).

**EDF**—Effective downwind forecast.

**EDM**—Effective downwind message (radioactive fallout).

## F

**FAA**—Federal aviation administration.

**FATHOMETER**—A device used to measure the depth of the ocean.

**FNMOC**—Fleet Numerical Meteorology and Oceanography Center, Monterey, California.

**FRONT**—The interface or transition zone between two air masses of different density. Since temperature is the most important regulator of atmospheric density, a front almost invariably separates air masses of different temperature.

## G

**GEOPHYSICS**—Used to mean working with the physical properties of both the air, land, and water, this term is occasionally used to describe the occupational field of Navy and Marine Corps weather personnel.

**GEOPOTENTIAL HEIGHT**—The height of a given point in the atmosphere calculated with respect to the energy in the column of air beneath the point, relative to sea level. In other words, an approximation of the height based on measured

temperatures, pressures, and humidity content of the supporting air column, and not necessarily an exact measured height.

**GF MPL**—Geophysics fleet mission program library.

**GHz**—Gigahertz, (1 billion hertz)

**GMT**—Greenwich mean time, a term replaced by coordinated universal time (UTC).

**GPM**—Geopotential meters, also gallons per minute.

**GZ**—round zero, the detonation point of a weapon, usually nuclear.

## H

**HDO**—Horizontal distance out (when evaluating upper winds); or hurricane duty officer.

**HECTOPASCAL (hPa)**—A unit of 100 pascals used to measure pressure, exactly equivalent to 1 millibar.

**HF**—High frequency.

**HSA**—Half-sector angle.

## I

**ICAO**—Abbreviation for international civil aviation organization.

**IFR**—Abbreviation for instrument flight rules.

**INFRARED (IR)**—The portion of the electromagnetic spectrum with wavelengths just slightly longer than visible light energy-thermal energy.

**INVERSION**—With respect to temperature, an increase in temperature with height. Normally temperature decreases with height in the atmosphere.

**IRCS**—International radio call sign.

**IREPS**—Integrated refractive effects prediction system.

**ISOTHERMAL**—Having an equal temperature throughout.

## K

**KHz**—Kilohertz; 1,000 hertz or cycles per second.

**KILOTON**—(KT) A multiplication factor for nuclear weapon yields. Each kiloton is equal to the explosive force of 1,000 tons of trinitrotoluene (TNT) explosive.



**kn**—Alternate abbreviation for knot. In meteorology, the more frequently used abbreviation is "kt", but this should not be confused with the uppercase "KT" meaning kiloton.

## L

**LAPSE RATE**—The decrease of an atmospheric variable with height: the variable being temperature unless otherwise specified.

**LCD**—Liquid crystal diode. A gray or black display of numbers or shapes commonly used in electronics.

**LITTORAL**—The coastal zone including the beach to the coastal waters.

**LLWS**—Low-level wind shear.

## M

**M-UNITS**—A unit of measurement used in electromagnetic refractivity calculations—a modification of N-Units.

**MEGATON**—(MT) A multiplication factor for nuclear weapon yields. Each megaton is equal to the explosive force of 1 million tons of trinitrotoluene (TNT) explosive.

**MET**—U.S. Navy mobile environmental team.

**METEOROLOGY**—The study of phenomenon of the atmosphere.

**METVANS**—USMC mobile meteorological vans. Highly transportable, completely equipped meteorological facilities constructed as complete modules in cargo containers. Modules may be used independently or connected to form complete, full-spectrum, meteorological support facilities in a forward deployed environment.

**MHz**—Megahertz, 1 million hertz.

**MILS**—An angular measurement scale in which 800 mils equals 45 degrees of arc; a circle is 6400 mils.

**MMF**—U.S. Marine Corps meteorological mobile facility-weather personnel who operate USMC Metvans.

**MRS**—Mini rawinsonde system.

**MSL**—Mean sea level, a suffix used after altitude measurements.

**MVFR**—Marginal visual flight rules.

## N

**NATO**—North Atlantic Treaty Organization.

**NAVAID**—An acronym for navigation aid, usually referring to an aircraft navigation aid such as an NDB, VOR, TACAN, VORTAC, or DME.

**NAVMETOCCOM**—Short title for Naval Meteorology and Oceanography Command headquartered at the Stennis Space Center, Mississippi.

**NAVSAR**—A GF MPL program used to help plan rescue searches at sea.

**NBC**—An acronym for nuclear, biological, or chemical.

**NOAA**—National Oceanic and Atmospheric Administration, a division of the U.S. Department of Commerce.

**NODDS**—Navy oceanographic data distribution system.

**NOMOGRAM**—Any graphic product used to find solutions to complex calculations without having to perform the calculations.

**NOTAM**—Notice to airmen.

**NTDS**—Navy tactical data system.

**NUC**—An abbreviation for nuclear; used within some NATO messages.

**NWS**—National weather service, a division of NOAA.

## O

**OA**—Abbreviation for shipboard aviation operations division, the shipboard division for which most Aerographer's Mates work.

**OOD**—Officer of the deck

## P

**PIBAL**—An acronym for pilot balloon, a small balloon tracked with a theodolite to determine wind direction and speed.

**PIREP**—Abbreviation for pilot report.

## Q

**QFE**—A signal used to indicate the value provided; the station pressure.

**QFF**—A signal used to indicate the value provided; the sea-level pressure.

**QNH**—A signal used to indicate the value provided; the minimum altimeter setting for the period of time discussed.

## R

**RABAL**—A method using radar to track a balloon carrying a radar-reflector, and is used to determine upper-level winds.

**RAD**—A unit of measurement of an absorbed dose of radiation equal to 100 ergs of ionization per gram of absorbing material or tissue.

**RADFO**—An acronym for radiological fallout.

**RADIOSONDE**—A device carried aloft by a balloon to measure pressure, temperature, and humidity content of the atmosphere.

**RAOB**—Acronym for radiosonde observation or rawinsonde observation.

**RATT**—Radio teletype.

**RAWINSONDE**—Radiosonde-wind sounding. A device carried aloft by balloon that measures pressure, temperature, humidity of the air, and the slant-range from the release point. Calculations on the change in pressure (height) and change in slant-range (distance) yield wind speed and direction.

**REFRACTIVITY**—The study of how electromagnetic energy is bent (refracted) as it moves through different density layers within the atmosphere.

**RH**—Usual abbreviation for relative humidity.

**RIA**—Radiosonde initial analysis, a GFMPL program used to analyze upper-air soundings.

**ROCKETSONDE**—A device carried aloft by a rocket which measures pressure, temperature, and humidity as it drifts on a parachute to the ground.

**ROCOB**—Acronym for rocketsonde observation.

## S

**SALINITY**—A measurement of the amount of salts dissolved in sea water.

**SAR**—Search and rescue.

**SMOOS**—Shipboard meteorological and oceanographic observing system.

**SSI**—Showalter stability index.

**SURFCAST**—(or SURFCST) Acronym for surf forecast.

**SUROB**—Acronym for surf observation.

**SYNOPTIC**—In general, pertaining to or affording an overall view. In meteorology, this term has become specialized in referring to the use of meteorological data obtained simultaneously over a wide area for presenting a comprehensive picture of the state of the atmosphere.

## T

**TACAN**—Tactical air navigation, a radio aircraft navigation aid used originally by the military to provide a pilot with direction and distance to a TACAN transmitter.

## U

**UHF**—Ultra-high frequency radio transmission.

**UNREP**—Underway replenishment.

**USW**—Undersea Warfare.

**UTC**—Universal time coordinated (Coordinated Universal Time), usually suffixed with a "Z".

**UTM**—Universal transverse mercator coordinates, a military coordinate system based on a series of grids used to locate positions between 84°N and 80°S.

## V

**VALID**—Effective, good.

**VEERING**—A change in the wind direction in a clockwise manner in the Northern Hemisphere, or a counter-clockwise manner in the Southern Hemisphere.

**VELOCIMETER**—In general, a device used to measure velocity (speed). In oceanography, the sound velocimeter measures the speed of sound in water.

**VERTREP**—Vertical replenishment by use of helicopters.

**VL**F—Very-low frequency.

**W**

**W**BGT—Wet-bulb globe temperature.

**W**EATHER—The state of the atmosphere with respect to its effect upon life and human activities.

**W**MO—World meteorological organization.

**X**

**X**BT—Expendable bathythermograph, usually referring to the probe that is dropped in the water and not recovered.

**X**SV—Expendable sound velocimeter, usually refers to probes that are dropped in the water and not recovered.



**APPENDIX II**

**MARSDEN SQUARE NUMBER**

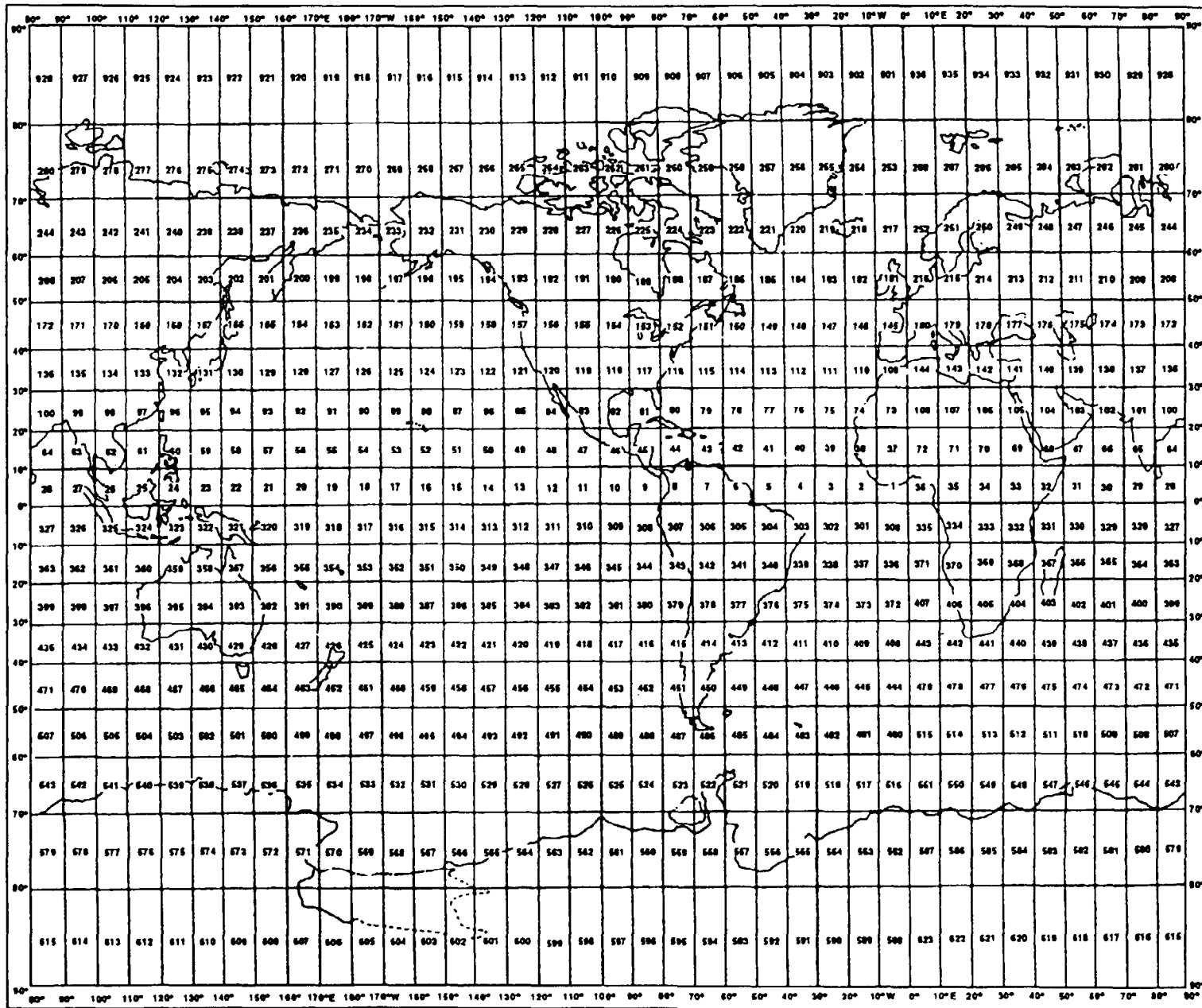

Figure AII-1.—Marsden square number.

## APPENDIX III

### WMO Code 3333

Q <sub>c</sub> = Quadrant of the globe		
Code	Latitude	Longitude
1	North	East
3	South	East
5	South	West
7	North	West





## APPENDIX IV

# WMO Code 1770

<b>III<sub>3</sub> = Instrument type for XBT, with fall rate equation coefficients</b>		
Code figure	Instrument	Equation Coefficients a and b
001	Sippican T-4	6.472, -2.16
002	Sippican T-4	6.691, -2.25
011	Sippican T-5	6.828, -1.82
021	Sippican Fast Deep	6.346, -1.82
031	Sippican T-6	6.472, -2.16
032	Sippican T-6	6.691, -2.25
041	Sippican T-7	6.472, -2.16
042	Sippican T-7	6.691, -2.25
051	Sippican Deep Blue	6.472, -2.16
052	Sippican Deep Blue	6.691, -2.25
061	Sippican T-10	6.301, -2.16
071	Sippican T-11	1.779, -0.255
201	TSK T-4	6.472, -2.16
202	TSK T-4	6.691, -2.25
211	TSK T-6	6.472, -2.16
212	TSK T-6	6.691, -2.25
221	TSK T-7	6.472, -2.16
222	TSK T-7	6.691, -2.25
231	TSK T-5	6.828, -1.82
241	TSK T-10	6.301, -2.16
401	Spartan XBT-1	6.301, -2.16
411	Spartan XBT-3	5.861, -0.0904
421	Spartan XBT-4	6.472, -2.16
431	Spartan XBT-5	6.828, -1.82
441	Spartan XBT-5DB	6.828, -1.82
451	Spartan XBT-6	6.472, -2.16
461	Spartan XBT-7	6.472, -2.16
471	Spartan XBT-7DB	6.472, -2.16
481	Spartan XBT-10	6.301, -2.16
491	Spartan XBT-20	6.472, -2.16
501	Spartan XBT-20DB	6.472, -2.16
700	Sippican XCTD standard	
710	Sippican XCTD deep	
720	Sippican AXCTD	
730	Sippican SXCTD	
800	Mechanical BT	
810	Hydrocast	
820	Thermistor chain	
830	CTD	

## WMO Code 4770

<b>X<sub>R</sub>X<sub>R</sub>=Recorder type</b>	
Code figure	Recorder
01	Sippican Strip Chart Recorder
02	Sippican MK2A/SSQ-61
03	Sippican MK-9
04	Sippican AN/BHQ-7/MK8
05	Sippican MK-12
10	Spartan SOC BT/SV Processor Model 100
20	Argos XBT-ST
21	CLS-ARGOS/Protecno XBT-ST model 1
22	CLS-ARGOS/Protecno XBT-ST model 2
30	BATHY Systems SA-810
31	Scripps Metrobyte controller
32	Murayama Denki Z-60-16 III
33	Murayama Denki Z-60-16 II
34	Protecno ETSM2
35	Nautilus Marine Service NMS-XBT
40	TSK MK-2A
41	TSk MK-2S
42	TSK MK-30
43	TSK MK-30N
99	Unknown

## APPENDIX V

### DEGREES TO MILS CONVERSION

AZIMUTH MEASUREMENTS - DEGREES TO MILS							
deg	Mils	deg	Mils	deg	Mils	deg	Mils
0	0	90	1600	180	3200	270	4800
5	89	95	1689	185	3289	275	4889
10	178	100	1778	190	3378	280	4978
15	267	105	1867	195	3467	285	5067
30	356	110	1956	200	3556	290	5156
25	445	115	2045	205	3645	295	5245
30	533	120	2133	210	3733	300	5333
35	622	125	2222	215	3822	305	5422
40	711	130	2311	220	3911	310	5511
45	800	135	2400	225	4000	315	5600
50	889	140	2489	230	4089	320	5689
55	978	145	2578	235	4178	325	5778
60	1067	150	2667	240	4267	330	5867
65	1156	155	2756	245	4356	335	5956
70	1245	160	2845	250	4445	340	6045
75	1333	165	2933	255	4533	345	6133
80	1422	170	3022	260	4622	350	6222
85	1511	175	3111	265	4711	355	6311
90	1600	180	3200	270	4800	360	6400



## APPENDIX VI

# REFERENCES USED TO DEVELOP THE TRAMAN

**NOTE:** Although the following references were current when this TRAMAN was published, their continued currency cannot be assured. When consulting these references, keep in mind that they may have been revised to reflect new technology or revised methods, practices, or procedures. You therefore, need to ensure that you are studying the latest references.

### Chapter 1

Federal Meteorological Handbook No. 3, FCM-H3, *Rawinsonde and Pibal Observations*, U.S. Department of Commerce/National Oceanic and Atmospheric Administration, 1997.

*MARWIN MW 12 User's Guide*, (AN/UMQ-12), VAISALA OY, Helsinki, Finland, 1994.

*Mini Rawin System Operating Procedure*, (AN/UMQ-12), MWOP-00139-3.2, VAISALA OY, Helsinki, Finland, 1988.

*United States Navy Meteorological and Oceanographic Support System Manual*, NAVMETOCCOMINST 3140.1(K), Commander, Naval Meteorology and Oceanography Command, Stennis Space Center, MS, 1996.

WMO Publication No. 306, Manual on Codes, Vol. I, *International Codes* 1995 Edition, Secretariat of the World Meteorological Organization, Geneva, Switzerland, 1995.

### Chapter 2

Blumenthal, Barry P. and Kroner, Stephen M., *Guide to Common Shipboard Expendable Bathythermograph (SXB T) Recording Malfunctions*, Naval Oceanographic Office Reference Publication RP 21, Naval Oceanographic Office, Stennis Space Center, MS, 1981.

*Collection and Reporting of Bathythermograph Observations*, OPNAVINST 3141.1, 1990.

*Fleet Oceanographic and Acoustic Reference Manual*, Naval Oceanographic Office Reference Publication RP 33, Naval Oceanographic Office, Stennis Space Center, MS, 1992.

*Maintenance Manual for Bathythermograph Set AN/SSQ-(56, 56A, 60, 61, and 61A)*, NAVSEA SE365-AA-MMM-010, Naval Sea Systems Command, 1993.

*Technical Manual for Bathythermograph/Sound Velocimeter AN/BQH-7A Oceanographic Data System Surface Ship Application*, NAVSEA SE365-BA-MMO-010/BQH-7, Naval Sea Systems Command, 1986.

*United States Navy Meteorological and Oceanographic Support System Manual*, NAVMETOCCOMINST 3140.1(K), Commander, Naval Meteorology and Oceanography Command, Stennis Space Center, MS, 1996.

WMO Publication No. 306, Manual on Codes, Vol. I, *International Codes* 1995 Edition, Secretariat of the World Meteorological Organization, Geneva, Switzerland, 1995.

### **Chapter 3**

*Aerodrome Forecast (TAF) Code*, NAVMETOCCOMINST 3143.1F, 1996.

*Procedures Governing Pilot Weather Reports (PIREPS)*, NAVMETOCCOMINST 3142.1A, 1996.

*Surface METAR Observations User's Manual*, NAVMETOCCOMINST 3141.2, Commander, Naval Meteorology and Oceanography Command, Stennis Space Center, MS, 1996.

*United States Navy Manual For Ship's Surface Weather Observations*, NAVMETOCCOMINST 3144.1D, Commander, Naval Meteorology and Oceanography Command, Stennis Space Center, MS, 1996.

WMO Publication No. 306, Manual on Codes, Vol. I, *International Codes* 1995 Edition, Secretariat of the World Meteorological Organization, Geneva, Switzerland, 1995.

### **Chapter 4**

*Joint Surf Manual*, COMNAVSURFPACINST/COMNAVSURFLANTINST 3840.1B, 1987.

*Operator's Manual, Tactical Environmental Support System (TESS (3.0)) and Shipboard Meteorological and Oceanographic Observing System (SMOOS), Vol. IIB*, NAVELEXCEN VJO 14203-0302428A, NISE WEST, Vallejo, CA, 1993.

### **Chapter 5**

*Basic Military Requirements*, NAVEDTRA 12043, Naval Education and Training Program Management Support Activity, Pensacola, FL, 1992.

*Military Requirements for Petty Officer Third Class*, NAVEDTRA 12044, Naval Education and Training Program Management Support Activity, Pensacola, FL, 1991.\*

*Operator's Manual, Tactical Environmental Support System (TESS (3.0)) and Shipboard Meteorological and Oceanographic Observing System (SMOOS), Vol. IIA*, NAVELEXCEN VJO 14203-0302428A, NISE WEST Vallejo, CA, 1993.

*Reporting Nuclear Detonations, Biological and Chemical Attacks, and Predicting and Warning of Associated Hazards and Hazard Areas*, Allied Tactical Publication (ATP) 45, Department of the Navy, Washington, D.C., 1984.

---

\*Effective 1 October 1996, the Naval Education and Training Program Management Support Activity became the Naval Education and Training Professional Development and Technology Center.

# INDEX

## A

Additional data groups, RAOB, 1-2

Air temperature

- BATHY code, 2-15
- DRIFTER code, 2-19
- TEMP code, 1-3, 1-11, 1-16, 1-19, 1-21 to 1-23, 1-28 to 1-32

Airborne expendable bathythermograph (AXBT), 2-2

Aircraft flight level observations, 1-3

Altitude, 1-1

AMDAR code, 1-20, 1-21

AN/BQH-7 oceanographic data system, 2-1, 2-2 to 2-3, 2-7

- maintenance, 2-8
- operation, 2-7

AN/SSQ-56(A) bathythermograph, 2-2 to 2-4, 2-6

AN/SSQ-60 bathythermograph, 2-3

AN/SSQ-61 (A) bathythermograph, 2-1, 2-2 to 2-3

- maintenance, 2-5
- operation, 2-4

AN/UMK-3 TESS version 3.0, 1-15, 4-10, 4-14, 4-16, 5-3

AN/UMQ-12( ) MRS, 1-4

AN/UYK-83( ) Mobile Oceanographic Support System (MOSS), 4-10, 4-14, 4-16

Anomalous features, bathythermograph, 2-11

Attack area, 5-10

## B

Balloon, 1-6

- color, 1-19
- conditioning, 1-7
- handling, 1-6 to 1-8
- inflation, 1-7
- lighting units, 1-19
- PIBAL, 1-3

## Balloon—Continued

- preparation, 1-6
- release, RAOB, 1-2, 1-10
- shrouds, 1-8
- storage, 1-6
- tying, 1-8

## Balloon ascension rate, 1-7, 1-8

- MRS observation, 1-5, 1-10
- PIBAL observation, 1-17

## BATHY code, 2-15

- air temperature, 2-15
- bottom depth, 2-16
- data identifier, 2-15
- date/time group, 2-15
- depth, 2-16
- IRCS, 2-16
- observation time, 2-15
- station identifier, 2-15, 2-16
- surface current, 2-16
- temperature, 2-15 to 2-16
- winds, 2-15

## Bathythermograph observation, 2-1 to 2-2

- anomalous features, 2-11
- encoding, 2-12 to 2-17
- equipment, 2-2 to 2-10
- evaluation, 2-10 to 2-11
- logs, 2-12 to 2-14
- malfunctions, 2-11
- records, 2-17
- reports, 2-17
- significant data points, 2-12

## Beach face, 4-2

## Beach familiarization, SUROB, 4-2, 4-4

## Beach orientation, 4-2

- Beach slope, 4-2
- Bottom depth, BATHY code, 2-16
- Bottom hydrography, 4-2
- Breaker, 4-4
  - angle, SUROB, 4-7
  - height, SUROB, 4-4
  - period, SUROB, 4-6
  - types, SUROB, 4-6
- Brevity code, 4-15
- Buoy identifier, 2-18
- Buoy position, 2-18
- C**
- Calibration data, MRS, 1-9
- Centigray, 5-6
- Charted currents, 2-16
- Charted depths, 2-16
- Chemical agent
  - air-contaminating, 5-11
  - ground-contaminating, 5-11
  - groups, 5-11
  - non-persistent, 5-10
  - persistent, 5-10
- Chemical contamination coverage, 5-9 to 5-16
  - critical weather parameters, 5-11 to 5-12
- Chemical contamination plotting, 5-14
- Chemical downwind
  - Direction (CDD), 5-10
  - Downwind hazard distance (DHD), 5-10
  - Forecast (CDF), 5-10
  - Message (CDM), 5-12
  - Speed (CDS), 5-10
- Chemical hazard area,
  - circular, 5-14
  - double triangular, 5-15 to 5-16
  - triangular, 5-15
- Chemical warfare terms, 5-10
- Coastal zone topography, 4-2
- CODAR code, 1-20, 1-21
- Contractions
  - in PIREPs, 3-6
- D**
- Data identifier
  - BATHY code, 2-15
  - DRIFTER code, 2-18 to 2-20
  - upper-air codes, 1-20 to 1-22
- Depth, BATHY code, 2-16
- Depth, DRIFTER code, 2-20
- Dew-point depression, 1-26
  - TEMP code, 1-26
- DHD, 5-10
- Downwind forecast, nuclear, 5-4 to 5-9
- Downwind hazard distance, 5-10
- Drift (current), 2-19
- DRIFTER code, 2-18
  - air temperature, 2-19
  - bathymetric data, 2-19
  - data identifier, 2-18
  - meteorological data, 2-19
  - oceanographic data, 2-19
  - pressure tendency, 2-19
  - quality control data, 2-20
  - salinity, 2-19
  - sea-level pressure, 2-19
  - sea-surface temperature, 2-19
  - surface current, 2-19
  - surface maritime data, 2-19
  - temperature/depth, 2-20
  - under-sea current, 2-20
  - wave height, 2-19
  - wave period, 2-19
  - winds, 2-19



Drifting buoy, 2-17

reports, 2-17

Dropsonde observations, 1-3

Early Transmission messages, TEMP code, 1-29

Effective Downwind Direction (EDD), 5-3

Effective Downwind Forecast (EDF), 5-2

Effective Downwind Message (EDM), 5-2

Effective Downwind Speed (EDS), 5-3

Environmental Meteorological Sounding Log, 1-32

Expansion angles, nuclear EDF, 5-2 to 5-3

## F

Fallout templates, 5-6 to 5-7, 5-9

Fixed Regional Levels

PILOT code, 1-30

TEMP code, 1-16

## G

Geophysics Fleet Mission Program Library (GFMPL),  
1-19

Grid north, 5-6 to 5-7

Grid zone, 5-6 to 5-7

Ground zero, 5-5

## H

Half-sector angles (HSA), 5-10

Hazard Area, 5-10

Height, 1-1

Humidity inversions, 1-13

Hydrography, 4-2

## I

Inflating balloons, 1-7

adjustments, 1-8

gases, 1-7

PIBAL, 1-19

Inflating balloons—Continued

RAOB, 1-7

International Radio Call Sign (IRCS), 2-16

## L

Latitude/longitude, TEMP code, 1-24, 1-27

Launcher

LM3A, 2-8

MX-7594A/SSQ-56, 2-3

MX-8577/SSQ-61, 2-1

Lighting unit, PIBAL, 1-19

Littoral current, 4-8

measuring, 4-8

rip currents, 4-8

LM3A launcher, 2-8

Location, buoy, 2-18

## M

M-units, 1-15

Mandatory levels, PILOT code, 1-30 to 1-31

Mandatory levels, TEMP code, 1-22 to 1-24, 1-28

Maximum wind

PILOT code, 1-30

TEMP code, 1-26

Meteorological buoys, 2-17

Meteorological parachutes, 1-8

Mils, 5-5

Mini-rawinsonde System (MRS), 1-4

additional data groups, 1-16

balloon inflation, 1-7

balloon release, 1-10

balloon tying, 1-8

calibration data, 1-9

data evaluation, 1-11

fixed regional levels, 1-15

inflation adjustments, 1-8

NAVAID signal check, 1-10

Mini-rawinsonde System (MRS)—Continued

- operation, 1-5
- preparation, 1-6
- receiver check, 1-6
- release authorization, 1-10
- report modification, 1-16
- significant humidity levels, 1-13
- significant temperature levels, 1-13
- significant wind levels, 1-15
- supplemental information, 1-15
- surface weather observation, 1-10
- telemetry checks, 1-10

Mobile Oceanography Support System (MOSS),  
*also see* MOSS

Modified Surf Index (MSI), 4-11

- breaker angle, 4-11 to 4-14
- breaker period, 4-11 to 4-14
- breaker type, 4-11 to 4-14
- relative wind, 4-11 to 4-14
- worksheet, 4-11

MRS, *see* Mini-rawinsonde system

MSI, *see* modified surf index

MX-7594A/SSQ-56 launcher, 2-3, 5-3

MX-8577/SSQ-61 launcher, 2-3, 5-3, 5-6

**N**

N-units, 1-15

NATO NBC reporting system, 5-1

NAVAID, 1-10

- signal check, 1-10

Naval Effective Downwind Forecast (NAV EDF), 5-2

Naval Effective Downwind Message (NAV EDM), 5-2

NBC warfare, 5-1

- publications, 5-1

- reporting system, 5-1

Nearshore, 4-2

NP agents, 5-10

Nuclear EDF yield groups, 5-2

Nuclear effective downwind forecast (EDF), 5-2

Nuclear effective downwind message (EDM), 5-4

**O**

Observation time

- BATHY code, 2-2

- MRS observation, 1-10

- PIBAL observation, 1-17

- upper-air, 1-20

Observing surf, 4-4 to 4-16

OC-14/SSQ-56 probe, 2-4

Ocean depth, 2-1

Oceanographic data set AN/BQH-7, 2-1

**P**

P agents, 5-10

Parachutes. meteorological. 1-8

PIBAL, 1-3, 1-17

- also see* PILOT code

- balloons, 1-19

- equipment, 1-17

- lights, 1-19

- observations, 1-17

- wind evaluation, 1-19

Pilot-reporting criteria, PREPS, 3-5

PILOT code, 1-29

- fixed regional levels, 1-30

- identification data, 1-30

- lower mandatory levels, 1-30

- lower significant levels, 1-30

- mandatory level winds, 1-30

- maximum wind, 1-30

- part A, 1-30

- part B, 1-30

- part C, 1-31

- part D, 1-31

PILOT code—Continued  
     regional data, 1-31  
     significant level winds, 1-30 to 1-31  
     upper mandatory levels, 1-31  
     upper significant levels, 1-31  
 PILOT MOBIL, 1-3, 1-29 to 1-30  
 PILOT SHIP, 1-3, 1-29 to 1-30  
 PIREP code, 3-5  
     contractions, 3-6  
     encoding, 3-5  
     forms, 3-7  
     pilot-reporting criteria, 3-5  
     records, 3-9  
     reports, 3-5 to 3-9  
     report form, 3-7  
     text element indicators, 3-8  
     transmission, 3-8  
 Plotting  
     chemical contamination, 5-9  
     radiological fallout, 5-5  
 Probe, bathythermograph  
     OC-14/SSQ-56, 2-3 to 2-4, 2-8  
     T-4, 2-8  
     T-5, 2-8  
     T-7, 2-8  
     XSV-01, 2-8  
**R**  
 RABAL observations, 1-3 to 1-6, 1-9 to 1-10  
 RADFO, 5-5  
     output, TESS, 5-4, 5-6  
 Radiological fallout, 5-1  
     plotting, 5-1  
 Radiosonde, 1-3  
     battery, 1-9  
     preparation, 1-9  
 Radiosonde code, *see* TEMP code  
     Radiosonde observation, 1-2  
         *also see* MRS  
 RAOB, 1-2  
     *also see* MRS  
 RAWIN, 1-2  
 Rawinsonde code, *see* TEMP code  
 Rawinsonde observations, 1-3  
     evaluation, 1-11  
     records, 1-31  
     *also see* MRS  
 Records  
     bathythermograph, 2-17  
     upper-air observations, 1-31 to 1-32  
 Regional data, TEMP code, 1-28  
 Rip currents, 4-8  
 RO-326A/SSQ-56 recorder, 2-3  
 RO-326B/SSQ-56 recorder, 2-3  
 RO-326C/SSQ-56 recorder, 2-3, 2-6  
 Rocketsonde observations, 1-3  
 ROCOB code, 1-3  
 RS-80 radiosonde, 1-9  
**S**  
 Salinity, 2-1  
     DRIFTER code, 2-19  
 Sandbar, 4-2  
 Sea-surface temperature, 1-28  
 Sea waves, 2-19  
 Seawater, 2-1  
     salinity, 2-1  
     traits, 2-1  
 Secondary surf, SUROB, 4-10  
 Set (current), 2-19  
 Shipboard expendable bathythermograph (SXBT), 2-2  
 Significant breaker height, 4-5, 4-11, 4-12  
 Significant levels, upper-air  
     humidity, 1-13

Significant levels, upper-air—Continued

- PILOT code, 1-30 to 1-31
- TEMP code, 1-26 to 1-29
- temperature, 1-13
- wind, 1-15

Station identifiers

- BATHY code, 2-16
- DRIFTER code, 2-18
- PILOT code, 1-30
- TAF code, 3-1
- TEMP code, 1-24

Supplemental information

- RAOB, 1-2

Surf, 4-1

Surf beat, 4-3

Surf forecasts (SURFCSTS), 4-1, 4-4

Surf observations (SUROB), 4-1, 4-4

- beach familiarization, 4-4
- breaker angle, 4-7, 4-11, 4-13
- breaker height, 4-4, 4-11, 4-12
- breaker period, 4-6, 4-11, 4-12
- breaker types, 4-6, 4-11, 4-12
- brevity code, 4-15
- elements, 4-4
- littoral current, 4-8, 4-11, 4-13
- Modified Surf Index (MSI), 4-11
- relative wind direction, 4-10, 4-11, 4-14
- remarks, 4-9
- reporting, 4-14
- rip currents, 4-8
- secondary surf, 4-10
- surf zone, 4-9
- weather conditions, 4-9
- worksheet, 4-5

Surf zone, 4-9

- characteristics, 4-1

Surf zone—Continued

- descriptive terms, 4-2
- hydrography, 4-2

Surface current

- BATHY code, 2-16
- DRIFTER code, 2-19

SUROB, *see* Surf observation

Swell waves, *see* sea waves

T

Tactical Environmental Support System (TESS)

TAF, *see* terminal aerodrome forecast

TEMP code, 1-22

- additional data, 1-16
- air temperature, 1-25
- dew-point depression, 1-25
- early transmission messages, 1-29
- humidity levels, 1-27
- identification data, 1-23, 1-24
- lower significant levels, 1-26, 1-30
- lower mandatory levels, 1-23, 1-30
- mandatory level data, 1-24
- maximum wind, 1-26
- message composition, 1-22
- message parts, 1-22
- part A, 1-22
- part B, 1-22
- part C, 1-22
- part D, 1-22
- pressure altitude, 1-25
- regional data, 1-16, 1-28
- sea-water temperature, 1-28
- significant level selection, 1-26
- station pressure, 1-25
- system status, 1-28
- temperature levels, 1-25, 1-26
- tropopause data, 1-25

TEMP code—Continued

- upper mandatory levels, 1-31
- upper significant levels, 1-31
- wind direction, 1-25, 1-28
- wind levels, 1-25, 1-28
- wind speed, 1-25, 1-26

TEMP DROP code, 1-21

TEMP MOBIL code, 1-21

TEMP SHIP code, 1-21

Temperature

- bathymetric, in BATHY code, 2-15 to 2-16
- bathymetric, in DRIFTER code, 2-19 to 2-20
- seawater, 2-1

Terminal Aerodrome forecast (TAF), 3-1

- amendment criteria, 3-3
- format, 3-1 to 3-3

TESS AN/UMK-3

- RADFO program, 5-3 to 5-4
- SURF program, 4-14
- TIDE program, 4-16

Text Element Indicators, PIREP, 3-8

Theodolite, 1-18

Tides, 4-15 to 4-16

- calculations, 4-16
- effects in surf zone, 4-15
- TESS program, 4-16

Tropopause data, TEMP code, 1-25

Tropopause level, 1-25

U

Undersea current, DRIFTER code, 2-20

Undersea warfare, 2-1

Universal balloon balance, 1-7 to 1-8

Upper-air observations, 1-1

- also see* MRS
- codes, 1-20
- location, 1-20

Upper-air observations—Continued

- publications, 1-3
- records, 1-31
- reports, 1-32
- station identifier, 1-11, 1-14, 1-22
- time, 1-11, 1-14, 1-20
- t y p e s , 1 - 2

Uprush zone, 1-4

W

Water depth, see Ocean Depth

Wave

- height, 4-1
- length, 4-1
- period, 4-1, 4-6
- refraction, 4-3
- speed, 4-1

Wave refraction, 4-3

Wind direction

- BATHY code, 2-15
- DRIFTER code, 2-19
- PILOT code, 1-30
- relative, 4-10
- TAF code, 3-2
- TEMP code, 1-25

Wind evaluation

- fixed regional levels, (twice), 1-15
- PIBAL observation, 1-19
- RAWIN observation, 1-3
- significant levels, (twice), 1-15, 1-28
- surf observations, 4-10

Wind speed

- BATHY code, 2-15
- DRIFTER code, 2-19
- PILOT code, 1-30
- TAF code, 3-2
- TEMP code, 1-25

**X**

XBT, *also see* bathythermograph

XSV, *also see* bathythermograph

XSV-01 probe, 2-8

**Y**

Yield groups, nuclear EDF, 5-2

**Z**

Zone of Immediate Operational Concern, 5-6

Zone of Secondary Hazard, 5-6

---

---

# *Assignment Questions*

---

---

**Information:** The text pages that you are to study are provided at the beginning of the assignment questions.





# ASSIGNMENT 1

Textbook Assignment: "Upper-Air Observations" and "Bathythermograph Observations," chapters 1 and 2, pages 1-1 through 2-12.

---

- 1-1. Upper-air observations measure what two levels of the atmosphere?
1. The troposphere and stratosphere
  2. The troposphere and mesosphere
  3. The stratosphere and mesosphere
  4. The mesosphere and thermosphere
- 1-2. What type of upper-air observation evaluates pressure, temperature, humidity, and wind direction and speed?
1. Radiosonde
  2. Rawinsonde
  3. Pibal
  4. Rocketsonde
- 1-3. What type of upper-air observation is used to measure lower-level winds only?
1. Radiosonde
  2. Rawinsonde
  3. Rabal
  4. Pibal
- 1-4. Which of the following publications contains detailed information on conducting Rawinsonde and Pibal observations?
1. WMO Publication 306
  2. NAVMETOCCOMINST 3140.1
  3. FMH-1
  4. FMH-3
- 1-5. What balloons are best suited for Rawinsonde observations during strong winds?
1. 100 gram
  2. 300 gram
  3. 600 gram
  4. 1,200 gram
- 1-6. What is the ideal ascension rate, in feet per minute, for a meteorological balloon?
1. 395 to 1,640 fpm
  2. 600 to 1,000 fpm
  3. 900 to 1,000 fpm
  4. 950 to 1,550 fpm
- 1-7. Of the following gases, which one is recommended for inflating meteorological balloons?
1. Helium
  2. Natural gas
  3. Hydrogen
  4. Oxygen
- 1-8. How much helium is required to achieve a 700-gram free-lift weight for a 100-gram balloon?
1. 25 cubic feet
  2. 40 cubic feet
  3. 50 cubic feet
  4. 65 cubic feet
- 1-9. Free lift must be increased during periods of precipitation or icing?
1. True
  2. False
- 1-10. Which of the following signals from the MRS unit indicates high quality reception from the radiosonde transmitter?
1. A steady tone
  2. A steady green light
  3. At least one asterisk displayed in the LCD window
  4. At least five asterisks displayed in the LCD window

- 1-11. Which of the following personnel grants permission for a radiosonde launch aboard ship?
1. Aft Lookout
  2. Master-At-Arms
  3. Officer of the Deck
  4. Executive Officer
- 1-12. When you use the MRS, abbreviations on the significant levels printout indicate the reason why the level was selected. Of the following abbreviations, which one indicates a maximum wind level?
1. T
  2. U
  3. TR
  4. MV
- 1-13. The "TEMP" function of the MRS produces what type of printout?
1. Coded message printout
  2. Raw data printout
  3. Pibal message printout
  4. Significant levels printout
- 1-14. Which of the following levels is NOT a mandatory significant level?
1. The surface level
  2. The tropopause
  3. The isopycnic level
  4. The base of a temperature inversion of 2.7°C at 420 hPa
- 1-15. When you use the MRS, how are Fixed Regional Level Winds (FRLW) determined?
1. They are automatically selected by the system
  2. They are read directly from the "winds" data printout
  3. They are manually selected and encoded
  4. Fixed Regional Level Winds are never reported when using the MRS
- 1-16. Which of the following activities should report significant level wind data in Part B of the TEMP code?
1. A National Weather Service station only
  2. All U.S. Navy ships, including those operating inside of WMO region IV
  3. A land station within the United States
  4. A mobile station within the United States
- 1-17. The additive data code group "10167" is used to report what type of information?
1. Wind vector information
  2. Tropopause information
  3. The type of equipment used to process the upper air sounding
  4. Levels of doubtful temperature data
- 1-18. Pilot balloon (PIBAL) observed winds are low-level wind measurements used primarily for tactical aircraft and para-drop operations.
1. True
  2. False
- 1-19. Which of the following software packages contains software for processing Pibal observations?
1. OAML
  2. GF MPL
  3. EOTDA
  4. AREPS
- 1-20. What size pilot balloon should be used for nighttime operations?
1. 10 gram
  2. 30 gram
  3. 50 gram
  4. 100 gram

1-21. When are black pilot balloons used for a Pibal observation?

1. Clear sky
2. Low-overcast sky
3. Hazy sky
4. High-overcast sky

1-22. Why are upper-air reports coded in a numerical form?

1. The information may be decoded internationally
2. A large amount of information can be transmitted by using only a few numbers
3. The code can be easily ingested into a computer
4. All of the above

1-23. When Part A of an upper-air report is transmitted from a mobile land site, what is the identifier group of the message?

1. IIAA
2. TTAA
3. UUA A
4. LLAA

1-24. If only one upper-air observation is conducted per day, for what synoptic hour is the observation conducted?

1. 0000Z only
2. 1200Z only
3. 0000Z or 1200Z, whichever is closer to local sunrise
4. 0600Z or 1800Z, whichever is closer to local sunrise

1-25. What parts of the TEMP code contain data for the standard atmospheric pressure surfaces?

1. Parts A and B
2. Parts A and C
3. Parts B and D
4. Parts C and D

```

UUAA NSHP 65121 99601 10249 25004 99996 11221 30502 00531 // // 92606 06017 27513
85303 01422 27515 70837 08908 25509 50536 26556 19009 40693 40157 16006 30883 51562 26020
25002 46381 28044 20151 4458628052 15343 45785 27562 10612 47185 27051 88334 50756 23019
77147 27567 40306;

```

Figure 1-A

- 1-26. In the TEMP code, if the YYGGI<sub>d</sub> group is encoded 62003 in Part A, what does the "62" and the "3" indicate?
1. All temperatures are in Celsius and the observation contains doubtful data
  2. All temperatures are in Fahrenheit and the observation contains doubtful data
  3. 12th day of the month, the winds are in meters per second and are reported to 300 hPa
  4. 12th day of the month, the winds are in knots and are reported to 300 hPa
- 1-27. What is the reported surface pressure?
1. 1060 hPa
  2. 999 hPa
  3. 996 hPa
  4. 601 hPa
- 1-28. What altitude is reported for the 925-hPa pressure level?
1. 006 meters
  2. 260 meters
  3. 606 meters
  4. 926 meters
- 1-29. What is the temperature at the 500-hPa pressure level?
1. 26.5°F
  2. 26.5°C
  3. -26.5°F
  4. -26.5°C
- 1-30. What is the dew-point depression at the 500-hPa level?
1. 5.6°C
  2. 6.0°C
  3. 16.0°C
  4. 56.0°C
- 1-31. What is the wind direction and speed reported at the 150-hPa pressure level?
1. 270° at 62 mps
  2. 270° at 162 kt
  3. 275° at 62 kt
  4. 275° at 162 mps

IN ANSWERING QUESTIONS 1-27 THROUGH 1-33, REFER TO FIGURE 1-A ABOVE AND TABLE 1-8 IN YOUR TRAMAN.

UUBB NSHP 75120 99302 51753 42505 00013 10636 11873 01558 22776 05750 33762 03368 44746  
 02767 55650 08567 66598 12758 77576 13962 88440 29163 99366 38160 11300 46357 22241 52147  
 33200 50330 21212 00013 30502 11900 30505 22915 28020 33820 27515 44700 25509 55630 22509  
 66520 19509 77450 18005 88380 16006 99350 19010 11320 22010 22300 26010 33270 27020 44180  
 28030 55155 27532 66100 27030 31313 46105 81135 90123 41414 43521;

Figure 1-B

- |  |   |
|--|---|
| <p>1-32. What is the reported height or pressure level of the tropopause?</p> <ol style="list-style-type: none"> <li>1. 334 hPa</li> <li>2. 147 hPa</li> <li>3. 3,340 meters</li> <li>4. 27,567 meters</li> </ol> <p>1-33. What is the direction and speed of the maximum wind?</p> <ol style="list-style-type: none"> <li>1. 210°/115 kt</li> <li>2. 210°/115 mps</li> <li>3. 275°/67 kt</li> <li>4. 275°/67 mps</li> </ol> | <p>1-36. What is the wind direction and speed at the 820-hPa level?</p> <ol style="list-style-type: none"> <li>1. 275° at 15 kt</li> <li>2. 275° at 15 mps</li> <li>3. 015° at 58 kt</li> <li>4. 015° at 58 mps</li> </ol> <p>1-37. What is the sea-surface temperature?</p> <ol style="list-style-type: none"> <li>1. +10.5°C</li> <li>2. +12.3°C</li> <li>3. +13.5°C</li> <li>4. -2.3°C</li> </ol> <p>1-38. What information is included in message Part C of the TEMP code?</p> <ol style="list-style-type: none"> <li>1. Mandatory levels at or below 100 hPa</li> <li>2. Mandatory levels above 100 hPa</li> <li>3. Significant levels at or below 100 hPa</li> <li>4. Significant levels above 100 hPa</li> </ol> <p>1-39. Which of the following data may be included as part of an Early Transmission Report?</p> <ol style="list-style-type: none"> <li>1. Maximum altitude of balloon</li> <li>2. Level of Free Convection</li> <li>3. Convective Condensation Level</li> <li>4. Stability Index</li> </ol> |
|--|---|
- IN ANSWERING QUESTIONS 1-34 THROUGH 1-37, REFER TO FIGURE 1-B ABOVE AND TABLE 1-9 IN YOUR TRAMAN.
- 1-34. What is the reported surface pressure?
1. 901.3 hPa
  2. 913.0 hPa
  3. 1001.3 hPa
  4. 1013.0 hPa
- 1-35. What is the dew-point depression at the 440-hPa level?
1. 6.0°F
  2. 6.3°C
  3. 13.0°C
  4. 21.0°F

PPBB 64121 72306 90012 10013 09523 10020 90346 11510 12005 12505 90789 14005 15508 16510  
 91246 17015 18019 18523 9205/ 20025 21530 9305/ 21050 21555 9405/ 21557 22060 950// 23065;  
 PPDD 64121 72306 955// 23070;

Figure 1-C

1-40. In the PILOT code, which of the code groups should be used to report "maximum wind within the sounding, using standard altitudes"?

1. 66P<sub>m</sub>P<sub>m</sub>P<sub>m</sub>
2. 6H<sub>m</sub>H<sub>m</sub>H<sub>m</sub>H<sub>m</sub>
3. 77H<sub>m</sub>H<sub>m</sub>H<sub>m</sub>H<sub>m</sub>
4. 77999

1-44. What rate of change in temperature is characteristic of (a) near-surface ocean water, and (b) deep-ocean water?

1. (a) rapid (b) rapid
2. (a) rapid (b) slow
3. (a) slow (b) rapid
4. (a) slow (b) slow

IN ANSWERING QUESTIONS 1-41 AND 1-42, REFER TO FIGURE 1-C.

1-41. What is the reported wind direction and speed at the 3,000-foot level?

1. 115° at 10 kt
2. 120° at 05 kt
3. 125° at 05 kt
4. 210° at 50 kt

1-45. How often are routine bathythermograph observations conducted from USW capable ships?

1. Once a day
2. Twice a day
3. Three times a day
4. Four times a day

1-42. What is the highest wind level reported in the observation?

1. 50,000 feet
2. 55,000 feet
3. 50,000 meters
4. 55,000 meters

1-46. What is the maximum depth of the standard XBT (T-4) probe?

1. 1,500 ft
2. 2,500 ft
3. 3,500 ft
4. 6,000 ft

1-43. What is the easiest method of transferring upper-air data to FNMOD, Asheville, for archiving?

1. Paper copy
2. AUTODIN message
3. Facsimile
4. Data diskette

1-47. When you place a new chart on the RO-326/SSQ-56 recorder, you should check the ready-for-launch mode calibration temperature and the alignment of the stylus on the surface depth line.

1. True
2. False

1-48. What is the purpose of the auxiliary signal output cable on the AN/BQH-7?

1. Connection to the hand-held LM3A launcher
2. Connection to the XSV-01 probe
3. Link-up to GPS
4. Link-up to NTDS

1-49. When the AN/BQH-7 system uses a T-4 probe and a sound velocity trace is recorded, sound velocity calculations are based on measured water temperature and what other value?

1. Actual measured salinity values
2. A standard salinity of 0‰
3. A standard salinity of 35‰
4. A standard salinity of 37‰

1-50. When should XSV-01 probes be used with the AN/BQH-7 system?

1. During training evolutions only
2. During actual warfare operations only
3. Whenever operating in a region where the water salinity does not average 35‰, or varies with depth
4. At all times; the XSV-01 is designed for use with the BQH-7

1-51. If the stylus on the RO-326/SSQ-56 recorder chart makes erratic excursions to the right of the chart paper, what is the probable cause?

1. Complete wire breakdown of probe
2. Leak from probe wire to salt water
3. Electromagnetic interference
4. Blown fuse on recorder

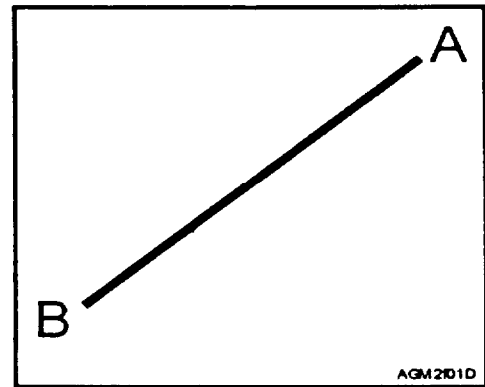

Figure 1-D

IN ANSWERING QUESTION 1-52, REFER TO FIGURE 1-D.

1-52. What is the type of gradient between points A and B?

1. Negative
2. Positive
3. Isothermal
4. Isovelocity

## ASSIGNMENT 2

Textbook Assignment: "Bathythermograph Observations," "Aviation Weather Codes," "Surf Observations," and "Plotting Radiological Fallout and Chemical Contamination Coverage," chapters 2 through 5, pages 2-13 through 5-16.

---

2-1. Which of the following points on a BT trace is NOT considered for analysis and reporting?

1. The surface
2. The mixed layer depth
3. The top of an isothermal layer
4. The mid-point of the thermocline

2-2. What is normally the maximum number of points that may be selected for a BT observation?

1. 15
2. 20
3. 25
4. 50

2-3. Which of the following activities should report surface wind direction and speed in bathythermograph observations?

1. Ships
2. Submarines
3. Aircraft
4. Coast Guard units only

JJYY 06087 0605/ 14324 15739 32807 40222 88888 00102 00211 10205 24145 99901 10120 50109 99903 40543 NSHP
---

Figure 2-A

WHEN ANSWERING QUESTIONS 2-4 THROUGH 2-6, REFER TO FIGURE 2-A.

2-4. What is the UTC observation date in the BATHY observation?

1. May 6th
2. June 5th
3. June 8th
4. August 6th

2-5. Which of the following groups is reporting recorder type and probe information?

1. 00102
2. 32807
3. 40222
4. 88888

2-6. What water depth and temperature is being reported by the groups 99901 10120?

1. 11 meters 1.2°C
2. 100 meters 12.0°C
3. 110 meters 12.0C
4. 1,101 meters -2.0°C

2-7. What code group is used to indicate a bottom depth and temperature reading?

1. 00000
2. 66666
3. 88888
4. 99999



2-8. If the last three groups of a BATI-IY report appear as "66666 10427 31009," what does the 10427 group indicate?

1. Surface current with set at 040°T and drift of 2.7 knots
2. Surface current with set at 270°T and drift of 4.0 knots
3. Actual water depth of 427 meters
4. Charted water depth of 427 meters

2-9. Where should unclassified bathythermograph observation log sheets be mailed to at the end of each month?

1. Naval Oceanographic Office, MS
2. National Oceanographic Data Center, Silver Spring, MD
3. Fleet Numerical Meteorology and Oceanography Center, CA
4. Commander, Naval Meteorology and Oceanography Command, MS

```
ZZYY 93789 10017 11014 101234
00234511119 01207 10123 29056 30132
4013352003 22219 00147 10202 33311
8887120010 30147 43505 20050 30131
4342520100 30117 43412 20150 30093
4341066091 20050 13090 20150 15100
444201// 10017 1000/ 71227 81101
90150
```

Figure 2-B

IN ANSWERING QUESTIONS 2-10 THROUGH 2-14, REFER TO FIGURE 2-B, A DRIFTING BUOY REPORT.

2-10. What is the observation date/time?

1. 10 Jan 1997 at 1014Z
2. 10 Jan 1997 at 1101Z
3. 1 Oct 1997 at 1014Z
4. 1 Oct 1997 at 1101Z

2-11. What is the buoy's reported position?

1. 12°34'N 23°45'E
2. 23°45'N 12°34'E
3. 1.234°N 2.345°E
4. 12.34°N 23.45°E

2-12. What is the reported (a) air temperature, and (b) sea-surface temperature?

1. (a) 12.3°C (b) 14.7°C
2. (a) 12.3°C (b) 20.2°C
3. (a) 12.7°C (b) 14.7°C
4. (a) 12.7°C (b) 20.2°C

2-13. What is the reported water temperature at 150 meters?

1. +0.93°C
2. -0.93°C
3. +9.30°C
4. -9.30°C

2-14. What is the set of the water current at 150 meters?

1. From 360°
2. Toward 360°
3. From 150°
4. Toward 150°

2-15. Routine TAFs are transmitted at what time intervals?

1. 00Z and 12Z only
2. 03Z and 15Z only
3. 03Z, 09Z, 15Z, 21Z
4. 00Z, 06Z, 12Z, 18Z

2-16. The contraction WSCONDS is used in the TAF code to indicate which of the following conditions?

1. Severe weather in the vicinity
2. Lightning
3. Wet runway conditions
4. Low-level wind shear

- 2-17. In the TAF code, what is indicated by the group "530305"?
1. Occasional, moderate turbulence in clear air between 3,000 and 5,000 feet
  2. Frequent, moderate turbulence in clear air between 3,000 and 8,000 feet
  3. Light icing, in precipitation between 3,000 and 8,000 feet
  4. Severe icing, in cloud between 3,000 and 5,000 feet
- 2-18. Which of the following contractions should be used in the TAF code to indicate temporary fluctuations in the weather lasting less than 1 hour?
1. FM
  2. BECMG
  3. TEMPO
  4. AMD
- 2-19. A TAF amendment would be required when a forecasted ceiling of 3,500 feet drops to 2,800 feet?
1. True
  2. False
- 2-20. In the PIREP code, what is the text element indicator "/TP" used to report?
1. Time of report
  2. Type of aircraft
  3. Outside air temperature
  4. Turbulence
- 2-21. When encoded in a PIREP, which of the following meteorological elements must always be spelled out?
1. Lightning
  2. Extreme turbulence
  3. Low-level wind shear
  4. Tornado
- 2-22. A PIREP beginning with the contraction "UUA" is used to report which of the following occurrences?
1. Tornadoes and waterspouts only
  2. Severe icing only
  3. Severe or extreme turbulence only
  4. Any hazardous weather
- 2-23. Which of the following publications contains comprehensive information on surf observation procedures?
1. NAVMETOCCOMINST 3140.1
  2. FMH-4
  3. NTP-3
  4. NWP 3-59.3
- 2-24. Which two factors create surf?
1. Ocean currents and sea waves
  2. Offshore winds and sea waves
  3. Topography and swell waves
  4. Onshore winds and swell waves
- 2-25. If the deep-water wave length is averaging 50 feet, how deep is the water in the surf zone where the waves begin to break?
1. 10 feet
  2. 25 feet
  3. 50 feet
  4. 100 feet
- 2-26. Which of the following actions occur when a deep-water wave "feels bottom"?
1. Wave speed and length decrease; wave height decreases
  2. Wave speed and length decrease; wave height increases
  3. Wave speed and length increase; wave height decreases
  4. Wave speed and length increase; wave height increases

- 2-27. Which of the following hydrographic features is the most important factor in determining breaker type?
1. Tides
  2. Shoreline configuration
  3. Beach slope
  4. Nearshore currents
- 2-28. Which of the following factors that affect surf height may change in a relatively short period of time?
1. Beach slope
  2. Beach face
  3. Deep-water sea wave height
  4. Offshore bottom hydrography
- 2-29. Refraction is the bending of waves toward areas of slower wave speed?
1. True
  2. False
- 2-30. What information is included in SUROB element ALFA?
1. To the nearest foot, average height of 100 consecutive observed breakers
  2. To the nearest foot, average height of only the highest one-third of 100 observed breakers
  3. To the nearest half-foot, average height of 100 consecutive observed breakers
  4. To the nearest half-foot, average height of only the highest one-third of 100 observed breakers
- 2-31. Spilling breakers generally occur on beaches with what type of slope?
1. Gentle
  2. Moderate
  3. Steep
  4. Extreme
- 2-32. What type of breaker is characterized by violent tumbling action and a loud explosive sound?
1. Spilling
  2. Plunging
  3. Surging
  4. Curling
- 2-33. You are standing on the beach looking seaward. Breakers are approaching the beach from your right, moving toward your left, making a 30-degree angle to the beach. How should the breaker angle be identified?
1. 30° left flank
  2. 30° right flank
  3. 60° left flank
  4. 60° right flank
- 2-34. An empty soda can is seen floating parallel to shore. If the can moves 67 feet during 1 minute, what is the approximate littoral current speed?
1. 6.700 kt
  2. 1.100 kt
  3. 0.670 kt
  4. 0.067 kt
- 2-35. In element HOTEL of the SUROB, how should wind direction be reported?
1. True bearings only
  2. Relative bearing to the beach
  3. Relative bearing to the task group
  4. Magnetic bearings only
- 2-36. What is the purpose of the Modified Surf Index?
1. Used as a "go/no go" decision aid for amphibious landings
  2. Used as a modification tool for surf forecasts
  3. Used to adjust the significant breaker height prior to reporting
  4. Used to calculate secondary significant breaker height

2-37. How often are SUROBs completed and forwarded to the task force commander?

1. Once every 6 hours
2. Once every 12 hours
3. Minimum reporting interval as directed, and whenever conditions change significantly
4. Every half-hour

2-38. How is the SUROB Brevity code transmitted?

1. Satellite
2. AUTODIN
3. Voice or flashing light
4. Facsimile chart

2-39. When do maximum rip current velocities usually occur?

1. During a falling tide
2. During a rising tide
3. During summer
4. During winter

2-40. How many low-tide periods occur with a diurnal tide?

1. One
2. Two
3. Three
4. Four

2-41. A NAV NBC 3 NUC message contains what type of information?

1. Initial report of NBC weapons use
2. NBC survey results from naval forces
3. Shipboard MOPP level status
4. Effective downwind message for naval forces

2-42. A nuclear effective downwind message (EDM) provides fallout information after a nuclear device has been detonated.

1. True
2. False

IN ANSWERING QUESTION 2-43, REFER TO FIGURE 5-2 IN YOUR TRAMAN.

2-43. What is the (a) downwind direction and (b) expansion angle for a 90 kiloton blast near 30N 120W?

1. (a) 015 (b) 145
2. (a) 145 (b) 015
3. (a) 150 (b) 050
4. (a) 155 (b) 060

2-44. Which of the following TESS programs calculates fallout information?

1. SLAP
2. EDORD
3. RADFO
4. CHAFF

2-45. Which of the following types of nuclear bursts produces the most fallout?

1. High-air burst
2. Low-air burst
3. Surface burst
4. Underwater burst

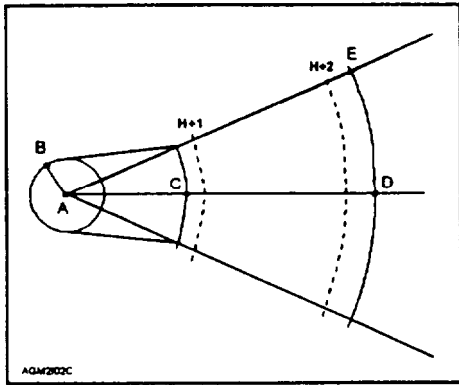

Figure 2-C

IN ANSWERING QUESTIONS 2-46 THROUGH 2-48, REFER TO FIGURE 2-C. THIS IS A REPRESENTATION OF A RADIOLOGICAL FALLOUT PLOT WITH POINT "A" AT GROUND ZERO.

2-46. When you use the TESS RADFO output and the effective downwind forecast (EDF), what value is used to determine the orientation of line AD?

1. Direction of the blast from the observer
2. Effective downwind direction
3. Expansion angle
4. Cloud top angle

2-47. When you use an effective downwind forecast (EDF) at sea, what value is used as radius AB to draw the circle around GZ?

1. The cloud radius provided in the Effective Downwind Forecast (EDF) message
2. The cloud radius obtained from the yield group on the Ship's Fallout Template
3. It is one-half of the downwind distance
4. It is one-third of the downwind distance

2-48. What is represented by the distance between points A and C?

1. It represents the Zone I hazard area
2. It represents the Zone II hazard area
3. It represents the cloud radius
4. It represents the safety distance

IN ANSWERING QUESTION 2-49, REFER TO FIGURE 5-8 IN YOUR TRAMAN.

2-49. What is the safety distance for a 150 kiloton weapon?

1. 5.0 nmi
2. 6.1 nmi
3. 7.0 nmi
4. 4.0 nmi

2-50. When a chemical agent is released under very light or calm wind conditions, the attack area and the hazard area will both be circular. At sea, what is the minimum radius of the attack area?

1. 1/2 nautical mile
2. 1/2 kilometer
3. 1 nautical mile
4. 2 kilometer





